

disklavier **ENSPIRE™**
ST/PRO

Owner's manual
Mode d'emploi
Bedienungsanleitung
Manual del propietario
Manuale d'uso e manutenzione

SPECIAL MESSAGE SECTION

PRODUCT SAFETY MARKINGS: Yamaha electronic products may have either labels similar to the graphics shown below or molded/stamped facsimiles of these graphics on the enclosure. The explanation of these graphics appears on this page. Please observe all cautions indicated on this page and those indicated on the safety instruction section.



SEE BOTTOM OF ENCLOSURE OR LOWER FRONT PANEL FOR GRAPHIC SYMBOL MARKINGS



The exclamation point within the equilateral triangle is intended to alert the user to the presence of important operating and maintenance (servicing) instructions in the literature accompanying the product.

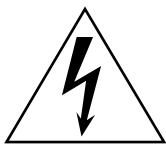

The lightning flash with arrowhead symbol within the equilateral triangle is intended to alert the user to the presence of uninsulated “dangerous voltage” within the product’s enclosure that may be of sufficient magnitude to constitute a risk of electrical shock.

IMPORTANT NOTICE: All Yamaha electronic products are tested and approved by an independent safety testing laboratory in order that you may be sure that when it is properly installed and used in its normal and customary manner, all foreseeable risks have been eliminated. DO NOT modify this unit or commission others to do so unless specifically authorized by Yamaha. Product performance and/or safety standards may be diminished. Claims filed under the expressed warranty may be denied if the unit is/has been modified. Implied warranties may also be affected.

SPECIFICATIONS SUBJECT TO CHANGE: The information contained in this manual is believed to be correct at the time of printing. However, Yamaha reserves the right to change or modify any of the specifications without notice or obligation to update existing units.

ENVIRONMENTAL ISSUES: Yamaha strives to produce products that are both user safe and environmentally friendly. We sincerely believe that our products and the production methods used to produce them, meet these goals. In keeping with both the letter and the spirit of the law, we want you to be aware of the following:

Battery Notice: This product MAY contain a small non-rechargeable battery which (if applicable) is soldered in place. The average life span of this type of battery is approximately five years. When replacement becomes necessary, contact a qualified service representative to perform the replacement.

Warning: Do not attempt to recharge, disassemble, or incinerate this type of battery. Keep all batteries away from children. Dispose of used batteries promptly and as regulated by applicable laws. Note: In some areas, the servicer is required by law to return the defective parts. However, you do have the option of having the servicer dispose of these parts for you.

Disposal Notice: Should this product become damaged beyond repair, or for some reason its useful life is considered to be at an end, please observe all local, state, and federal regulations that relate to the disposal of products that contain lead, batteries, plastics, etc.

NOTICE: Service charges incurred due to lack of knowledge relating to how a function or effect works (when the unit is operating as designed) are not covered by the manufacturer’s warranty, and are therefore the owners responsibility. Please study this manual carefully and consult your dealer before requesting service.

NAME PLATE LOCATION: The graphic below indicates the location of the name plate. The model number, serial number, power requirements, etc., are located on this plate. You should record the model number, serial number, and the date of purchase in the spaces provided below and retain this manual as a permanent record of your purchase.

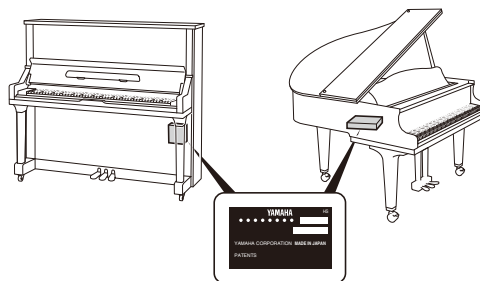

Model _____

Serial No. _____

Purchase Date _____

IMPORTANT SAFETY INSTRUCTIONS

WARNING — When using any electrical or electronic product, basic precautions should always be followed. These precautions include, but are not limited to, the following:

1. Read these instructions.
2. Keep these instructions.
3. Heed all warnings.
4. Follow all instructions.
5. Do not use this apparatus near water.
6. Clean only with dry cloth.
7. Do not block any ventilation openings. Install in accordance with the manufacturer's instructions.
8. Do not install near any heat sources such as radiators, heat registers, stoves, or other apparatus (including amplifiers) that produce heat.
9. Do not defeat the safety purpose of the polarized or grounding-type plug. A polarized plug has two blades with one wider than the other. A grounding type plug has two blades and a third grounding prong. The wide blade or the third prong are provided for your safety. If the provided plug does not fit into your outlet, consult an electrician for replacement of the obsolete outlet.
10. Protect the power cord from being walked on or pinched particularly at plugs, convenience receptacles, and the point where they exit from the apparatus.
11. Only use attachments/accessories specified by the manufacturer.
12. Use only with the cart, stand, tripod, bracket, or table specified by the manufacturer, or sold with the apparatus. When a cart is used, use caution when moving the cart/apparatus combination to avoid injury from tip-over. 
13. Unplug this apparatus during lightning storms or when unused for long periods of time.
14. Refer all servicing to qualified service personnel. Servicing is required when the apparatus has been damaged in any way, such as power-supply cord or plug is damaged, liquid has been spilled or objects have fallen into the apparatus, the apparatus has been exposed to rain or moisture, does not operate normally, or has been dropped.
15. This product shall not be exposed to dripping or splashing and that no objects filled with liquids, such as vases, shall be placed on the apparatus.
16. Do not put burning items, such as candles, on the apparatus.
17. Do not place this product or any other objects on the power cord or place it in a position where anyone could walk on, trip over, or roll anything over power or connecting cords of any kind. The use of an extension cord is not recommended! If you must use an extension cord, the minimum wire size for a 25' cord (or less) is 18 AWG. NOTE: The smaller the AWG number, the larger the current handling capacity. For longer extension cords, consult a local electrician.
18. **WARNING** — To reduce the risk of fire or electric shock, do not expose this apparatus to rain or moisture.
19. Care should be taken that objects do not fall and liquids are not spilled into the enclosure through any openings that may exist.
20. This product, either alone or in combination with an amplifier and headphones or speaker/s, may be capable of producing sound levels that could cause permanent hearing loss. DO NOT operate for a long period of time at a high volume level or at a level that is uncomfortable. If you experience any hearing loss or ringing in the ears, you should consult an audiologist. IMPORTANT: The louder the sound, the shorter the time period before damage occurs.
21. Some Yamaha products may have benches and/or accessory mounting fixtures that are either supplied as a part of the product or as optional accessories. Some of these items are designed to be dealer assembled or installed. Please make sure that benches are stable and any optional fixtures (where applicable) are well secured BEFORE using. Benches supplied by Yamaha are designed for seating only. No other uses are recommended.
22. This product shall be connected to a MAINS socket outlet with a protective earthing connection.
23. This product has a power switch for shutting off all system. The switch is located on the Power Supply Unit nearby the entrance of the AC cord. Note that the switch on the Controller does not shutdown all system.
24. Make sure that the plug of the Power Supply Unit's power cable can easily be disconnected from the AC outlet as a measure of precaution.

Outlets for Speakers

- Connect speakers of 2A or less of totals. Do not connect other products except speakers.
- Consult Yamaha service technician when using the outlets outside the purchased area.

**COMPLIANCE INFORMATION STATEMENT
(DECLARATION OF CONFORMITY PROCEDURE)**

Responsible Party : Yamaha Corporation of America
Address : 6600 Orangethorpe Avenue, Buena Park, CA 90620 USA
Telephone : 1-714-522-9011
Fax : 1-714-522-9301
Type of Equipment : Player Piano
Model Name : DGB1KENST, DGN1ENST, DGB1KENCL, DGN1ENCL, DGC1ENST, DGC2ENST, DC1XENST, DC2XENST, DC3XENST, DC3XENPRO, DC5XENPRO, DC6XENPRO, DC7XENPRO, DS4ENPRO, DS6ENPRO, DCF4ENPRO, DCF6ENPRO, DCFXENPRO, DU1ENST, DYUS1ENST, DYUS3ENST, DYUS5ENST

This device complies with Part 15 of the FCC Rules.

Operation is subject to the following two conditions:

- 1) this device may not cause harmful interference, and
 - 2) this device must accept any interference received including interference that may cause undesired operation.
- See user manual instructions if interference to radio reception is suspected.

The above statements apply ONLY to those products distributed by Yamaha Corporation of America or its subsidiaries.

FCC INFORMATION (U.S.A.)

1. IMPORTANT NOTICE: DO NOT MODIFY THIS UNIT!

This product, when installed as indicated in the instructions contained in this manual, meets FCC requirements. Modifications not expressly approved by Yamaha may void your authority, granted by the FCC, to use the product.

2. IMPORTANT: When connecting this product to accessories and/or another product use only high quality shielded cables. Cable/s supplied with this product MUST be used. Follow all installation instructions. Failure to follow instructions could void your FCC authorization to use this product in the USA.

3. NOTE: This product has been tested and found to comply with the requirements listed in FCC Regulations, Part 15 for Class "B" digital devices. Compliance with these requirements provides a reasonable level of assurance that your use of this product in a residential environment will not result in harmful interference with other electronic devices. This equipment generates/uses radio frequencies and, if not installed and used according to the instructions found in the users manual, may cause interference harmful to the operation of other electronic devices. Compliance with FCC regulations does not guarantee that interference will not occur in all installations. If this product is found to be the source of interference, which can be determined by turning the unit "OFF" and "ON", please try to eliminate the problem by using one of the following measures:

Relocate either this product or the device that is being affected by the interference.

Utilize power outlets that are on different branch (circuit breaker or fuse) circuits or install AC line filter/s.

In the case of radio or TV interference, relocate/reorient the antenna. If the antenna lead-in is 300 ohm ribbon lead, change the lead-in to coaxial type cable.

If these corrective measures do not produce satisfactory results, please contact the local retailer authorized to distribute this type of product. If you can not locate the appropriate retailer, please contact Yamaha Corporation of America, Electronic Service Division, 6600 Orangethorpe Ave, Buena Park, CA 90620

The above statements apply ONLY to those products distributed by Yamaha Corporation of America or its subsidiaries.

IMPORTANT NOTICE FOR THE UNITED KINGDOM

Connecting the Plug and Cord

IMPORTANT: The wires in mains lead are coloured in accordance with the following code:

GREEN-AND-YELLOW : EARTH
BLUE : NEUTRAL
BROWN : LIVE

As the colours of the wires in the mains lead of this apparatus may not correspond with the coloured markings identifying the terminals in your plug, proceed as follows:

The wire which is coloured GREEN and YELLOW must be connected to the terminal in the plug which is marked by the letter E or by the safety earth symbol or coloured GREEN and YELLOW.

The wire which is coloured BLUE must be connected to the terminal which is marked with the letter N or coloured BLACK.

The wire which is coloured BROWN must be connected to the terminal which is marked with the letter L or coloured RED.

Laite on liitettävä suojamaadoituskoskettimilla varustettuun pistorasiaan.

Apparatet må tilkoples jordet stikkontakt.

Apparaten skall anslutas till jordat uttag.

Information for Users on Collection and Disposal of Old Equipment



This symbol on the products, packaging, and/or accompanying documents means that used electrical and electronic products should not be mixed with general household waste.

For proper treatment, recovery and recycling of old products, please take them to applicable collection points, in accordance with your national legislation and the Directives 2002/96/EC.

By disposing of these products correctly, you will help to save valuable resources and prevent any potential negative effects on human health and the environment which could otherwise arise from inappropriate waste handling.

For more information about collection and recycling of old products, please contact your local municipality, your waste disposal service or the point of sale where you purchased the items.

[For business users in the European Union]

If you wish to discard electrical and electronic equipment, please contact your dealer or supplier for further information.

[Information on Disposal in other Countries outside the European Union]

This symbol is only valid in the European Union. If you wish to discard these items, please contact your local authorities or dealer and ask for the correct method of disposal.

Information concernant la Collecte et le Traitement des déchets d'équipements électriques et électroniques



Le symbole sur les produits, l'emballage et/ou les documents joints signifie que les produits électriques ou électroniques usagés ne doivent pas être mélangés avec les déchets domestiques habituels.

Pour un traitement, une récupération et un recyclage appropriés des déchets d'équipements électriques et électroniques, veuillez les déposer aux points de collecte prévus à cet effet, conformément à la réglementation nationale et aux Directives 2002/96/EC.

En vous débarrassant correctement des déchets d'équipements électriques et électroniques, vous contribuerez à la sauvegarde de précieuses ressources et à la prévention de potentiels effets négatifs sur la santé humaine qui pourraient advenir lors d'un traitement inapproprié des déchets.

Pour plus d'informations à propos de la collecte et du recyclage des déchets d'équipements électriques et électroniques, veuillez contacter votre municipalité, votre service de traitement des déchets ou le point de vente où vous avez acheté les produits.

[Pour les professionnels dans l'Union Européenne]

Si vous souhaitez vous débarrasser des déchets d'équipements électriques et électroniques veuillez contacter votre vendeur ou fournisseur pour plus d'informations.

[Information sur le traitement dans d'autres pays en dehors de l'Union Européenne]

Ce symbole est seulement valable dans l'Union Européenne. Si vous souhaitez vous débarrasser de déchets d'équipements électriques et électroniques, veuillez contacter les autorités locales ou votre fournisseur et demander la méthode de traitement appropriée.

Verbraucherinformation zur Sammlung und Entsorgung alter Elektrogeräte



Befindet sich dieses Symbol auf den Produkten, der Verpackung und/oder beiliegenden Unterlagen, so sollten benutzte elektrische Geräte nicht mit dem normalen Haushaltsabfall entsorgt werden.

In Übereinstimmung mit Ihren nationalen Bestimmungen und den Richtlinien 2002/96/EC, bringen Sie alte Geräte bitte zur fachgerechten Entsorgung, Wiederaufbereitung und Wiederverwendung zu den entsprechenden Sammelstellen.

Durch die fachgerechte Entsorgung der Elektrogeräte helfen Sie, wertvolle Ressourcen zu schützen und verhindern mögliche negative Auswirkungen auf die menschliche Gesundheit und die Umwelt, die andernfalls durch unsachgerechte Müllentsorgung auftreten könnten.

Für weitere Informationen zum Sammeln und Wiederaufbereiten alter Elektrogeräte, kontaktieren Sie bitte Ihre örtliche Stadt oder Gemeindeverwaltung, Ihren Abfallentsorgungsdienst oder die Verkaufsstelle der Artikel.

[Information für geschäftliche Anwender in der Europäischen Union]

Wenn Sie Elektrogeräte ausrangieren möchten, kontaktieren Sie bitte Ihren Händler oder Zulieferer für weitere Informationen.

[Entsorgungsinformation für Länder außerhalb der Europäischen Union]

Dieses Symbol gilt nur innerhalb der Europäischen Union. Wenn Sie solche Artikel ausrangieren möchten, kontaktieren Sie bitte Ihre örtlichen Behörden oder Ihren Händler und fragen Sie nach der sachgerechten Entsorgungsmethode.

Información para Usuarios sobre Recolección y Disposición de Equipamiento Viejo



Este símbolo en los productos, embalaje, y/o documentación que se acompañe significa que los productos electrónicos y eléctricos usados no deben ser mezclados con desechos hogareños corrientes.

Para el tratamiento, recuperación y reciclado apropiado de los productos viejos, por favor llévelos a puntos de recolección aplicables, de acuerdo a su legislación nacional y las directivas 2002/96/EC.

Al disponer de estos productos correctamente, ayudará a ahorrar recursos valiosos y a prevenir cualquier potencial efecto negativo sobre la salud humana y el medio ambiente, el cual podría surgir de un inapropiado manejo de los desechos.

Para mayor información sobre recolección y reciclado de productos viejos, por favor contacte a su municipio local, su servicio de gestión de residuos o el punto de venta en el cual usted adquirió los artículos.

[Para usuarios de negocios en la Unión Europea]

Si usted desea deshacerse de equipamiento eléctrico y electrónico, por favor contacte a su vendedor o proveedor para mayor información.

[Información sobre la Disposición en otros países fuera de la Unión Europea]

Este símbolo sólo es válidos en la Unión Europea. Si desea deshacerse de estos artículos, por favor contacte a sus autoridades locales y pregunte por el método correcto de disposición.

Informazioni per gli utenti sulla raccolta e lo smaltimento di vecchia attrezzatura



Questo simbolo sui prodotti, sull'imballaggio, e/o sui documenti che li accompagnano significa che i prodotti elettriche e elettroniche non dovrebbero essere mischiati con i rifiuti domestici generici.

Per il trattamento, recupero e riciclaggio appropriati di vecchi prodotti, li porti, prego, ai punti di raccolta appropriati, in accordo con la Sua legislazione nazionale e le direttive 2002/96/CE.

Smaltendo correttamente questi prodotti, Lei aiuterà a salvare risorse preziose e a prevenire alcuni potenziali effetti negativi sulla salute umana e l'ambiente, che altrimenti potrebbero sorgere dal trattamento improprio dei rifiuti.

Per ulteriori informazioni sulla raccolta e il riciclaggio di vecchi prodotti, prego contatti la Sua amministrazione comunale locale, il Suo servizio di smaltimento dei rifiuti o il punto vendita dove Lei ha acquistato gli articoli.

[Per utenti imprenditori dell'Unione europea]

Se Lei desidera disfarsi di attrezzatura elettrica ed elettronica, prego contatti il Suo rivenditore o fornitore per ulteriori informazioni.

[Informazioni sullo smaltimento negli altri Paesi al di fuori dell'Unione europea]

Questo simbolo è validi solamente nell'Unione europea. Se Lei desidera disfarsi di questi articoli, prego contatti le Sue autorità locali o il rivenditore e richieda la corretta modalità di smaltimento.

disklavier **EN SPIRE™**
ST/PRO

Owner's manual

Welcome to the Yamaha Disklavier™!

Thank you for purchasing the Yamaha Disklavier!

The Disklavier is a fascinating instrument that integrates a classic Yamaha acoustic piano with innovative electronics to suit your entertainment, educational, and creative needs, while retaining the tone, touch and long-term value that have long made Yamaha pianos the world's finest.

Before using your Disklavier piano, please read this manual thoroughly and retain it for future reference.

■ Notes on Source Code Distribution

For three years after the factory shipment, you may request from Yamaha the source code for any portions of the product which are licensed under the GNU General Public License by writing to the following address:

10-1 Nakazawa-cho, Naka-ku, Hamamatsu, Shizuoka, 430-8650, JAPAN
Piano Development Department, Yamaha Corporation

The source code will be provided at no charge; however, we may require you to reimburse Yamaha for the cost of delivering the source code to you.

- Note that we shall bear no responsibility whatsoever for any damage arising from changes (additions/deletions) made to the software for this product by a third party other than Yamaha (or party authorized by Yamaha).
- Note that re-use of source code released to the public domain by Yamaha is unguaranteed, and Yamaha shall not bear any responsibility whatsoever for the source code.

■ Trademarks & Copyrights

- The contents of this manual and the copyrights thereof are under exclusive ownership by Yamaha Corporation.
- Yamaha, Disklavier, Disklavier ENSPIRE, Silent Piano, DisklavierRadio, PianoSoft, and PianoSoftPlus are trademarks of Yamaha Corporation.
- SmartKey and CueTIME are trademarks of Yamaha Corporation or Yamaha Corporation of America.
- Disklavier ENSPIRE software, Copyright © 2016 Yamaha Corporation.
- This contains programs licensed under the GNU General Public License, GNU Lesser General Public License, the BSD Copyright, the Artistic License, and others.
- This product includes software developed by the OpenSSL Project for use in the OpenSSL Toolkit. (<http://www.openssl.org/>)
- App Store is a trademark of Apple Inc., registered in the U.S. and other countries.
- Android and Google Play are trademarks of Google Inc.
- The company names and product names in this manual are the trademarks or registered trademarks of their respective companies.

Important Precautions

Read the following before operating the Disklavier.

■ Warnings

- Do not locate the Disklavier in a place subject to excessive heat, low temperatures, or direct sunlight. This could be a fire hazard and may damage the finish and internal parts.
- Excessive humidity or dust can lead to fire or electric shock.
- Connect the plug on the Disklavier power cable to a compatible AC outlet. Failure to do so will present a fire and electric shock hazard. If the power cable plug is not compatible with your AC outlet, consult your dealer.
- Do not plug several devices into the same AC outlet. This can overload the AC outlet, and lead to a fire and electric shock hazard. It may also affect the performance of some devices.
- Do not place heavy objects on the power cable. A damaged power cable is a potential fire and electric shock hazard. If the power cable runs under a carpet, make sure heavy objects, including the Disklavier, are not placed on top of the cable.
- If the power cable is damaged (i.e. cut or a bare wire is exposed), ask your dealer for a replacement. Using the Disklavier in this condition is a fire and shock hazard.
- When disconnecting the power cable from an AC outlet, always pull from the plug. Never pull the cable. Damaging the cable in this way is a potential fire and electric shock hazard.
- The cover of the unit should be removed only by qualified service technicians.
- Do not place liquid containers such as vases, potted plants, glasses, cosmetic bottles, medicines, etc., on top of the Disklavier.
- Do not try to modify the Disklavier, as this could lead to a fire or electric shock hazard.
- When moving the Disklavier to another location, turn off the power, remove the power plug from the AC outlet, and remove all cables connected to external devices.
- Set the volume level on all the devices to minimum before applying power.
- Do not play the Disklavier at a high volume for extended periods; you may damage your hearing. This is especially important when using headphones. If you think your hearing ability is impaired, consult your doctor.
- If the Disklavier is overexposed to high amounts of stress — caused by the prolonged playback of extreme concentrations of data — the Disklavier's thermal relay may trip. The thermal relay will automatically reset when the Disklavier has cooled down.
- If you notice any abnormality — such as smoke, odor, or noise — turn off the Disklavier immediately, and remove the power plug from the AC outlet. Consult your dealer for repair.
- If a foreign object or water gets inside the Disklavier turn it off immediately, and remove the power plug from the AC outlet. Consult your dealer.
- If you plan not to use the Disklavier for a long period of time (such as when you are on vacation), disconnect the instrument from the power outlets.
- Always remove the power plug from the AC outlet before cleaning the Disklavier. Leaving the power plug connected presents a risk of electric shock.
- Do not use benzene, thinner, cleaning detergent, or a chemical cloth to clean the Disklavier.
- Do not place metal objects with rubber feet on top of the Disklavier. The color and finish of the Disklavier can be damaged.
- Do not place heavy objects on the Disklavier. Doing so can damage the Disklavier.
- Use a soft, dry cloth to clean the Disklavier. However, if you discover a stain, carefully use a soft damp cloth to remove it.

■ Cautions

- Turn off all audio devices when connecting to the Disklavier. Refer to the user's guide for each device. Use the correct cables and connect as specified.

■ Interference

- The Disklavier uses high-frequency digital circuits that may cause interference to radios and TVs placed close to it. If interference does occur, relocate the affected equipment.

Please keep this manual for future reference.

Table of Contents

Chapter 1 Introduction

Features	1
Items Supplied with the Disklavier	1
Names of Parts and Their Functions.....	2
Compatible Media and File Format.....	7
Basic Disklavier Terminology	8

Chapter 2 Getting Started

Connecting the AC Power Cable	9
Turning the Power On/Off	10
Connecting the Disklavier and Smart Device to a Network.....	12
Choosing the Network Connection Method.....	13
Wireless Network Connection by WPS	15
Wired Network Connection	17
Direct Wireless Connection.....	18
Using the ENSPIRE Controller App	19
IDC Registration.....	19

Chapter 3 Other Settings

Updating the Disklavier	20
Initializing Network Settings	21

Chapter 4 Troubleshooting

Error Indications	24
-------------------------	----

Chapter 5 Glossary.....25

Chapter 6 Specifications

General Specifications	27
------------------------------	----

Appendix	XG Voice List.....	A-1
	XG Drum Kit List.....	A-4
	MIDI Data Format.....	A-6

MIDI IMPLEMENTATION CHART

Introduction

Features

The Disklavier ENSPIRE offers many valuable features that open up new musical possibilities for you to explore. Here are brief explanations of such features:

Automatic performance from a real acoustic piano

- Non-contact optical sensors detect the movement of the keys with a high level of fidelity, recording and reproducing the most delicate nuances of any piano performance. This reproduces not only the movement of the keys, but also of the pedals, and even half-pedaling, delivering a performance almost indistinguishable from that of a real pianist. What's more, the PRO model features hammer sensor feedback, allowing reproduction of the nuances of techniques such as rapid note repetition and softly-played notes. You can even directly adjust the volume of the beautiful acoustic piano sound.
- 500 well-known piano pieces are stored internally, ranging in genre from classical right through to popular music and jazz, there for you to enjoy as the mood takes you. Songs including vocals from Yamaha artists even allow you to experience the atmosphere of a live performance, and Yamaha also provides the 24-hour DisklavierRadio streaming service.

Convenient functions

- Practice effectively by recording your own piano performances for playback and objective checking later, or practice playing the right hand part to a piece with just the left hand recorded. You can record recitals or daily practice sessions, allowing you to save and replay treasured moments.
- Silent Piano™ function that lets you use headphones for quiet practice sessions at night. Enjoy performing with the faithfully sampled sound of the Yamaha CFX concert grand piano.
- SmartKey feature that shows you the next key to play with by moving the keys slightly — an ideal function for beginners. Playing the keys in the order shown leads you through the song, allowing even beginning players to enjoy practicing.

Simple, intuitive operation

- Use a tablet or smartphone for easy operation.
- Choose from 500 piano pieces stored in the internal memory or purchased songs, letting you create your own unique playlists of favorites.
- Use the buttons on the switch box for easy playback. The buttons are in an unobtrusive location, meaning you can enjoy the authentic appearance of an acoustic piano in your living space.

Items Supplied with the Disklavier

Check that the following items are supplied with your Disklavier:

- Monitor speaker^{*1}*2 × 2
- Monitor speaker installation kit^{*1}*2 × 2
- Stereo headphones × 1
- Owner's manual × 1
- Built-in song list × 1
- Music book "50 greats for the Piano" × 1
- USB wireless LAN adaptor (UD-WL01) × 1

^{*1} Only for grand pianos.

^{*2} Not supplied on some models.

Names of Parts and Their Functions

■ Switch Box (Front and Bottom Panel)

Front panel

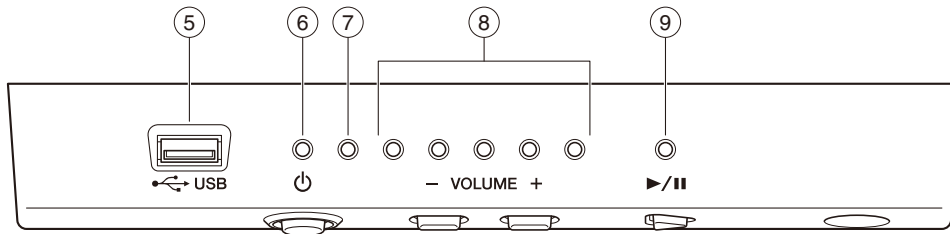

Bottom panel

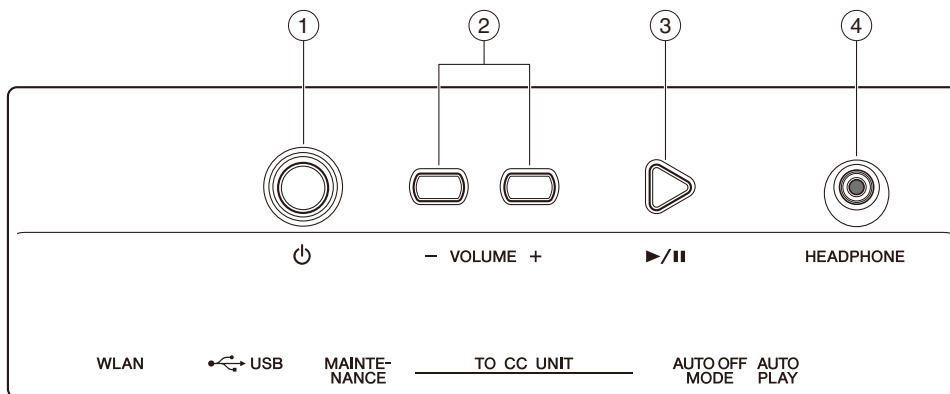

① POWER button

Turns on or off the Disklavier.

② VOLUME +/- buttons

Adjust the volume.

③ PLAY/PAUSE button

Starts and pauses playback.

- Playback starts from the last loaded song before turning the power off.
- If the last song cannot be loaded, playback starts from the first song of the internal demo songs.

④ HEADPHONE jack

Used to connect the headphones. Connecting headphones mutes the sound from the monitor speakers.

Caution:

- To prevent damage to your hearing, refrain from raising the volume to excessive levels, and do not use the headphones for extended periods of time.
- Do not pull the headphone cord or apply excessive force on the plug. This can damage the headphone and lead to sound output malfunction.

Note:

The keying sound of the keyboard remains even when the headphones are connected.

⑤ USB port

Used to connect the USB flash memory.

Note:

The unit cannot detect the USB flash memory if two or more memories are connected at the same time.

⑥ POWER indicator

Shows the status of power.

Condition	Status
Lit	The power is turned on.
Dim lit	The power is turned off (standby).
Flashing	The unit is shutting down.
Slow flashing	The unit is starting up.

⑦ Error indicator

Flashes when some error has occurred. See “Error Indications” on page 24.

⑧ VOLUME indicators

Show the volume level (10 steps). Each indicator shows the volume in 2 steps with brightness.

⑨ PLAY/PAUSE indicator

Shows the status of playback.

Condition	Status
Lit	The song is being played back.
Turning off	The song playback is paused or stopped.

■ Switch Box (Rear Panel)

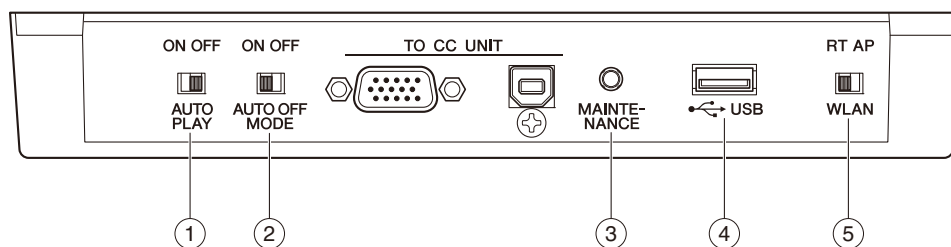

① AUTO PLAY switch

Activates or deactivates the auto play function. You can make settings for the auto play function using the ENSPIRE Controller app.

② AUTO OFF MODE switch

Activates or deactivates the auto power-off function. Set this switch to ON to turn the power off automatically if you do not use the Disklavier for the time specified with the ENSPIRE Controller app.

Note:

When set to ON, the Disklavier automatically turns off under the following conditions:

- No operation is performed on the switch box.
- No operation is performed on the ENSPIRE Controller app.
- The keyboard is not being played.
- The Disklavier does not receive the MIDI data.

③ MAINTENANCE button

For service personnel only. Do not touch this button.

④ USB port

Used to connect the USB wireless LAN adaptor (UD-WL01).

Note:

The unit cannot detect the USB flash memory if two or more memories are connected at the same time.

⑤ WLAN switch

Sets the method for wireless LAN connection when connecting the USB wireless LAN adaptor to the USB port. See “Connecting the Disklavier and Smart Device to a Network” on page 12.

■ Control Center Unit (for Grand Pianos)

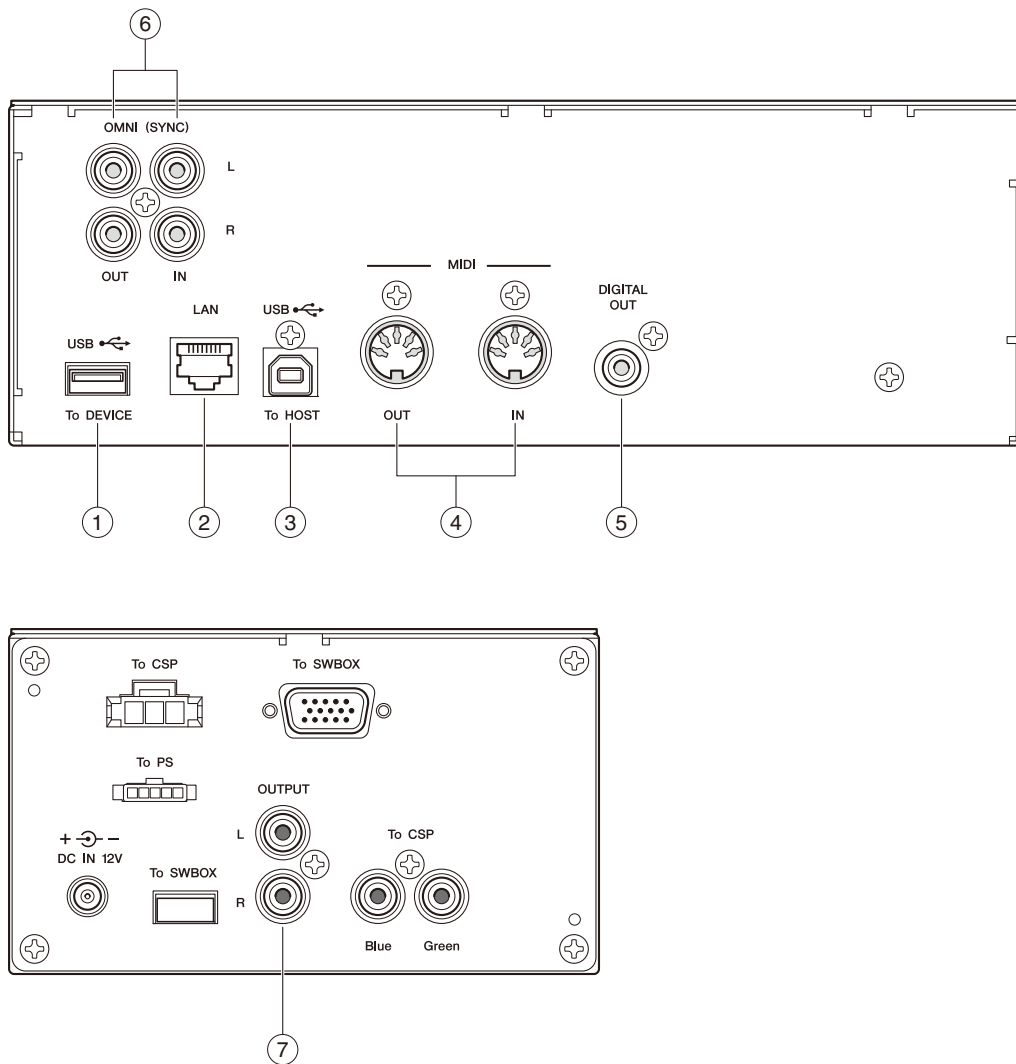

① USB (To DEVICE) port

Used to connect the USB flash memory.

Note:

The unit cannot detect the USB flash memory if two or more memories are connected at the same time.

② LAN port

Used to connect the router or hub using an Ethernet cable.

③ USB (To HOST) port

Used to connect the computer using a USB cable.

④ MIDI IN/OUT jacks

Used to connect to the MIDI input or output jacks of external MIDI devices using MIDI cables.

⑤ DIGITAL OUT jack

Used to connect to the digital input jack of external audio device using a digital coaxial cable.

⑥ OMNI (SYNC) IN/OUT jacks

Used to connect to the input or output jacks of external audio devices using RCA cables.

⑦ OUTPUT jacks

Used to connect the monitor speakers.

■ Inlet Box (for Upright Pianos)

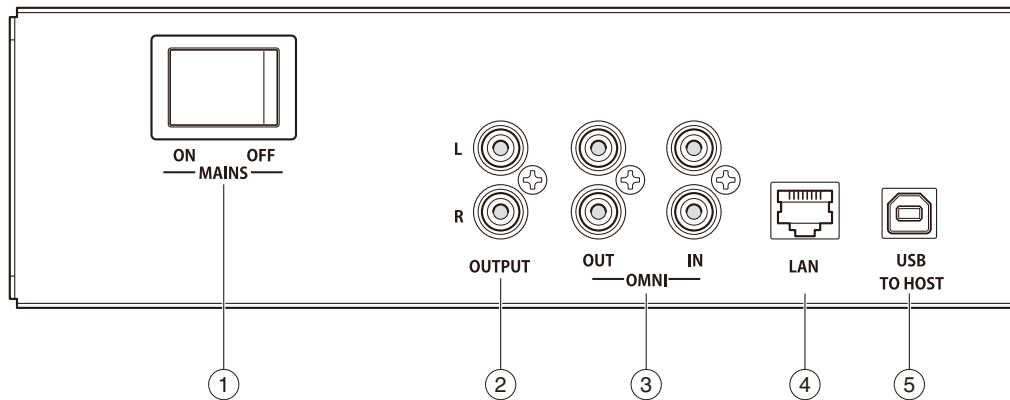

① **Main switch**

Turns on or off the main power.

② **OUTPUT jacks**

Used to connect optional monitor speakers.

③ **OMNI IN/OUT jacks**

Used to connect to the input or output jacks of external audio devices using RCA cables.

④ **LAN port**

Used to connect the router or hub using an Ethernet cable.

⑤ **USB (To HOST) port**

Used to connect the computer using a USB cable.

■ Monitor Speaker (for Grand Pianos)*

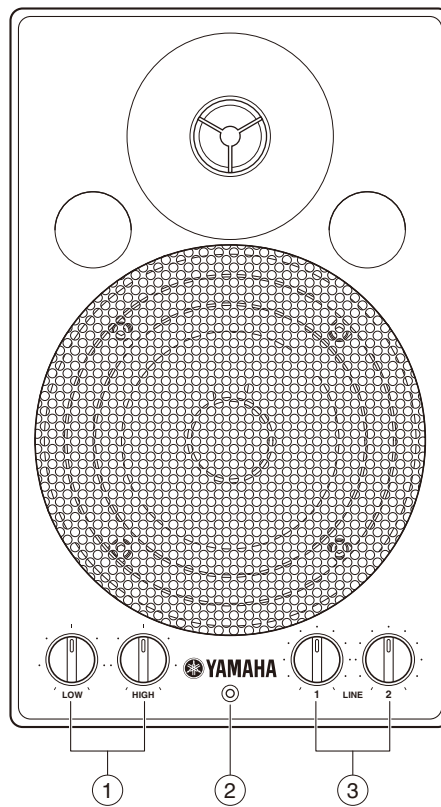

① **LOW/HIGH volume controls**
Adjust the bass/treble sound volume.

② **Power indicator**
Lights up while the speaker is turned on.

* Not supplied on some models.

Note:

There may be a notation that says “Only for use with the Disklavier M4 or E3.” to the tag attached to the AC power cable, however you can use it with the Disklavier ENSPIRE series.

③ **LINE 1/2 volume controls**
Adjust the sound volume for each line input.

Note:

For normal use, turn down the LINE 2 volume completely, and turn up the LINE 1 volume to the three o'clock position.

Compatible Media and File Format

Compatible Device

USB Flash Memory

- The USB flash memory should be formatted in FAT16 or FAT32 file system.
- Check that the USB flash memory is free of memory and software protection before attempting to use it, as these kinds of protection will prohibit access to the memory.
- The Disklavier is USB 2.0 compliant. You can also connect USB 3.0 devices, however data will be transferred at USB 2.0 speeds.

Compatible File Formats

The Disklavier can handle these four types of file format:

Song Format	File Format	Extension
MIDI	SMF0 Standard MIDI File format 0 for playback and recording.	.MID
	SMF1 Standard MIDI File format 1 for playback only.	.MID
Audio	WAV Uncompressed audio file format commonly used to create standard audio CDs. The Disklavier can play back 44.1kHz/16bit stereo WAV files.	.WAV
	MP3 Compressed audio file format commonly used in computers and smart devices.	.MP3

Caution:

- Do not remove the USB flash memory or turn on or off the power during data transfer as breakage may result.
- Do not insert and remove the USB flash memory too frequently as breakage may result.
- Be careful not to bump the USB flash memory with your legs when it is connected to the unit.
- Do not insert any objects other than the USB flash memory into the USB port as it may become unusable.

Note:

Yamaha does not assure the operation of the commercially available USB flash memories.

Basic Disklavier Terminology

The following is a list of several basic Disklavier words that you may need to know before proceeding with operational procedures in this manual. For additional Disklavier terminology, see the glossary provided in Chapter 5.

Ensemble Song

An ensemble song contains the same left- and right-hand parts as an L/R song, and extra tracks that are played by the internal XG tone generator. Accompanying tracks can include acoustic bass, drums, strings, vibes, etc.

L/R Song

In an L/R song, the left-hand piano part is stored on track 1 (L) and the right-hand piano part is stored on track 2 (R). During playback you can cancel either part, and practice that part yourself.

MIDI

An acronym for Musical Instrument Digital Interface. MIDI allows electronic musical instruments to communicate with each other.

PianoSoft

PianoSoft software contains prerecorded songs made by Yamaha for use with the Disklavier series. Many titles are available, and among the many musical styles included are classical, jazz, and popular. Selections include songs for listening enjoyment, piano study disks for the piano student, and accompaniments for vocal and instrumental practice. PianoSoft is sometimes used as a generic term for PianoSoft and PianoSoftPlus.

PianoSoft

PianoSoftAudio

PianoSoftAudio software contains real audio and MIDI signals for playing back on the Disklavier.

PianoSoftPlus

PianoSoftPlus

PianoSoftPlus software contains prerecorded ensemble songs featuring instrumental accompaniment that can be played back on the Disklavier.

Song

A “song” usually means a short piece of music with lyrics. However, in the Disklavier manuals the term “song” is used to refer to any piece of music.

Tone Generator

An electronic device that generates instrument voices. The Disklavier has an internal XG tone generator that can produce nearly 480 instrumental and percussion voices.

Voice

The sounds produced by a tone generator reproducing various instruments.

XG

XG

Yamaha XG is an extension of the GM (General MIDI) format. With greater polyphony, more voices, and effects, it improves song compatibility between MIDI devices. When a song in the Yamaha XG format is played on another XG compatible tone generator or synthesizer, it will play and sound as the original composer/creator intended.

Connecting the AC Power Cable

- 1 Connect the AC power cable extending from the piano to the AC wall outlet.

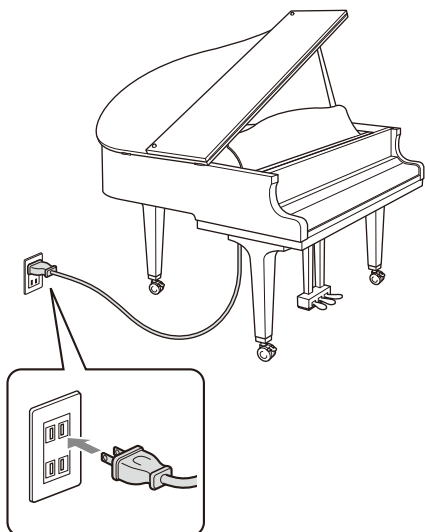
**Warning:**

Use the AC power cable attached to the piano. Use of other AC power cables may result in damage, overheating, or fire.

Caution:

- Do not stretch the cable or bend its ends.
- Do not attempt to use the cable if it is stretched or if the ends of the cable have been bent. Attempting to do so may cause interruptions to the power supply.
- Always turn off the main unit power before disconnecting the AC power cable.
- When you wish to move the piano, unplug the AC power cable from the AC outlet before proceeding.
- Unplug the AC power cable from the AC outlet if you do not intend to use the instrument for an extended period of time.

Turning the Power On/Off

■ Turning the Power On

- 1** Make sure that the main switch on the power supply unit/
inlet box is turned on.

(Grand piano)

Power supply unit
(located underneath
the piano)

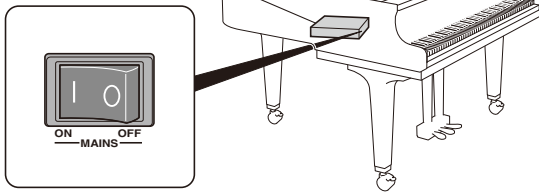

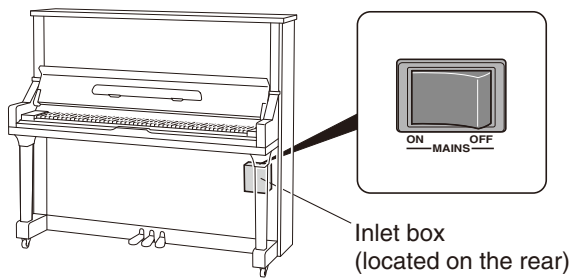

(Upright piano)

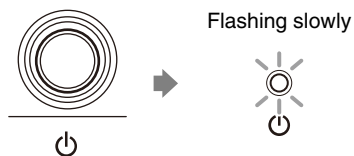

- 2** Press the POWER  button.

The POWER  indicator flashes slowly (every one second).



After several seconds, the POWER  indicator lights up.
Your Disklavier is now ready for use.

Getting Started

■ Turning the Power Off (Standby)

1 Press the POWER button.

The POWER  indicator flashes (every 0.5 seconds).

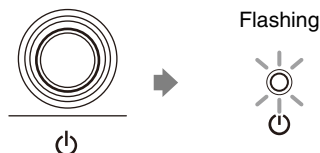

After several seconds, the POWER  indicator lights up dimly.

■ Setting the Auto Power-off Function

You can turn the power off automatically if you do not use the Disklavier for the time specified with the ENSPIRE Controller app.

1 Set the AUTO OFF MODE switch on the rear of the switch box.



Setting	Description
ON (default)	The auto power-off function is activated. The Disklavier is automatically turned off if you do not use it for the time specified with the ENSPIRE Controller app.
OFF	The auto power-off function is deactivated. Use the POWER  button to turn the power off.

Note:

When set to ON, the Disklavier automatically turns off under the following conditions:

- No operation is performed on the switch box.
- No operation is performed on the ENSPIRE Controller app.
- The keyboard is not being played.
- The Disklavier does not receive the MIDI data.

Connecting the Disklavier and Smart Device to a Network

By connecting your Disklavier and smart device to a network, you can enjoy a variety of features through the Internet Direct Connection (IDC) services or control the Disklavier using your smart device (ENSPIRE Controller app).

Internet Direct Connection (IDC)

Internet Direct Connection (IDC) is a feature that allows you to connect your Disklavier directly to the Internet. IDC users are able to listen to a streaming broadcast (DisklavierRadio), and receive valuable information such as product updates. Your Disklavier can be upgraded remotely as new technologies and services are developed through the IDC service.

To fully control your Disklavier with the ENSPIRE Controller app, you must connect your Disklavier and smart device.

Here is the summary for connection:

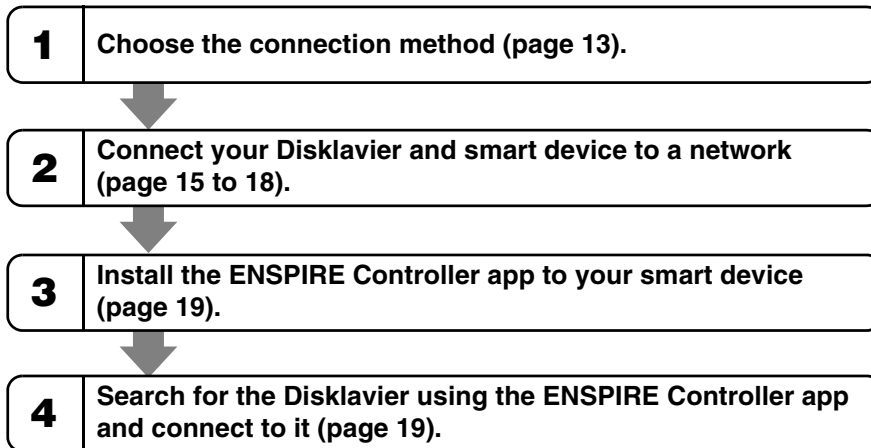

■ Preparations

- To use the Internet connection, you will first need to subscribe to an Internet service or provider.
- Use a computer to obtain and configure Internet service. You cannot obtain Internet service or configure router settings on a local area network using the Disklavier itself.

Note:

- The Disklavier ENSPIRE attempts to achieve a balance between security and usability in its network implementation. However, a determined hacker may be able to defeat these security measures and utilize the network of the purchaser in an unauthorized manner. Since each network is different, only the purchaser can determine whether the security measures discussed here will adequately protect their network.
- The purchaser acknowledges that connection to the Internet and use of the Disklavier ENSPIRE Internet features is done at the risk of the purchaser. In no event shall Yamaha, its subsidiaries or Yamaha's and/or its subsidiaries' directors, officers, or employees be responsible for unauthorized access, loss or alteration of the data of the purchaser or be liable for any damage from intrusions.

Choosing the Network Connection Method

You can use one of the three methods of connections below. Select one which is most suitable for your network environment.

■ Wireless Network Connection by WPS (👉 page 15)

Choose this if you have a wireless router (access point) that supports WPS. Connection will be established via a wireless router (access point).

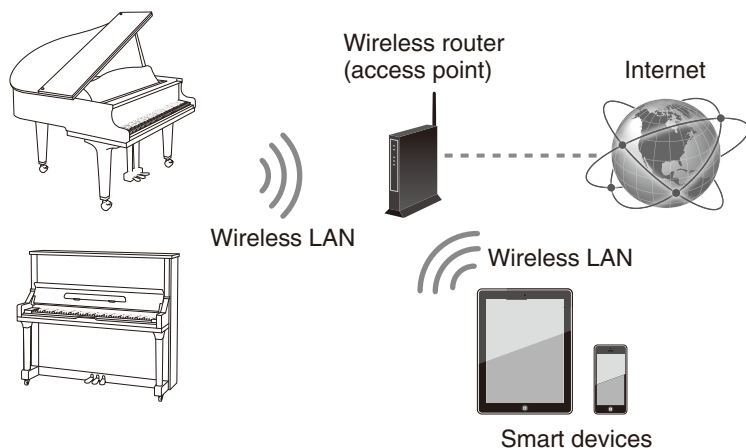

Requirements:

- USB wireless LAN adaptor (UD-WL01)
- Wireless router (access point) that supports WPS

WPS (Wi-Fi Protected Setup)

WPS is a wireless networking standard that makes connections between a router and wireless devices faster and easier. A router with WPS functionality is required to use WPS. Consult your wireless router (access point) specifications for compatibility information.

■ Wired Network Connection (👉 page 17)

Choose this if you have a wireless router (access point) that does not support WPS. Connection will be established via wireless router (access point).

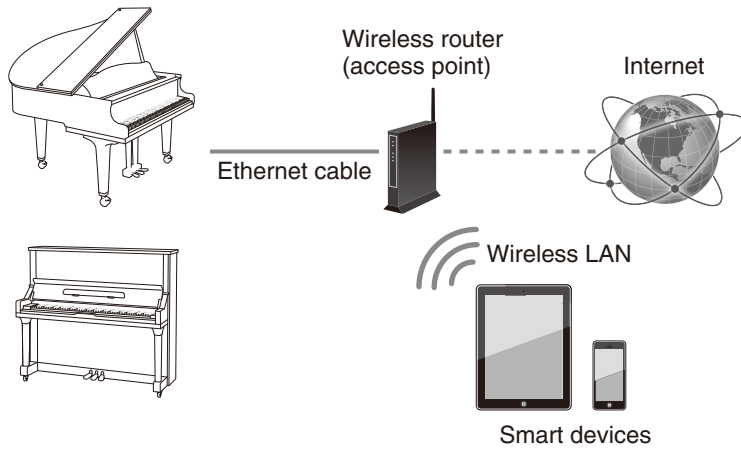

Requirements:

- Ethernet cable
- Wireless router (access point)

■ Direct Wireless Connection (👉 page 18)

Choose this if you do not have a wireless router (access point) or there is no wireless router (access point) available nearby. You can use the Disklavier as an access point to establish a direct wireless connection between the Disklavier and your smart device.

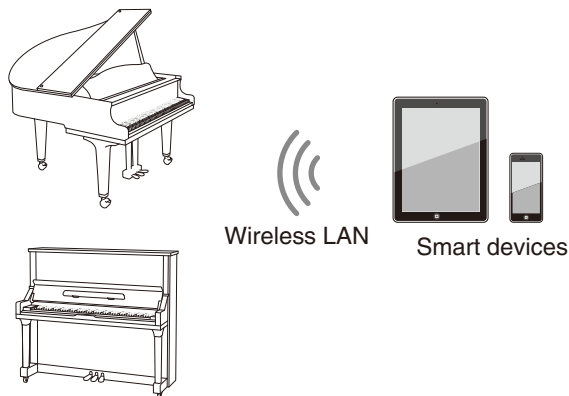

Requirements:

- USB wireless LAN adaptor (UD-WL01)

Note:

Use an STP (shielded twisted pair) cable for connection.

Note:

If the Disklavier is connected directly to your smart device, no Internet access is available on your smart device.

Wireless Network Connection by WPS

If your wireless router (access point) supports WPS, you can easily connect the Disklavier to a network just by following the procedures below, without making any additional settings, such as entering a password.

- 1** Press the POWER  button to turn the power off.
- 2** Connect the USB wireless LAN adaptor (UD-WL01) to the USB port on the rear of the switch box.

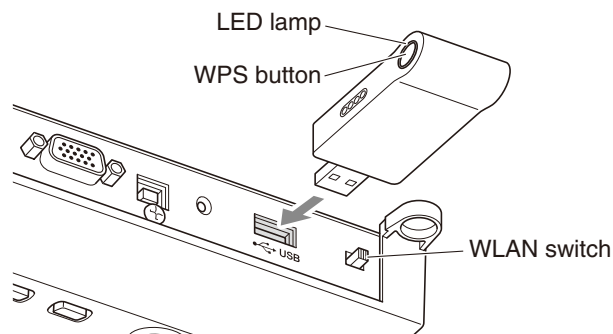

- 3** Check that the WLAN switch on the rear of the switch box is set to “RT.”

RT AP



WLAN

- 4** Press the POWER  button to turn the power on.
- 5** Hold down the WPS button on the USB wireless LAN adaptor (UD-WL01) for at least five seconds.

The LED lamp on the USB wireless LAN adaptor (UD-WL01) flashes every 0.5 seconds.

Note:

To check whether your wireless router (access point) supports WPS, refer to the owner's manual supplied with your wireless router (access point).

6 Press the WPS button on your wireless router (access point) within two minutes after step 5.

When the Disklavier is successfully connected to the wireless router (access point), the LED lamp on the USB wireless LAN adaptor (UD-WL01) lights up.

Connection between the Disklavier and the wireless router (access point) is now established. Once the Disklavier is connected to your wireless router (access point) by WPS, the setting will be remembered by the Disklavier, and you will not need to repeat this process the next time.

7 Open the Wi-Fi setting screen on your smart device.

8 Enable the Wi-Fi function.

9 From the network list shown on the screen, tap on the network to which you connected your Disklavier.

If necessary, enter a password, and then connect.

Note:

For details on the WPS setting, refer to the owner's manual supplied with your wireless router (access point).

Note:

For details on the Wi-Fi setting, refer to the owner's manual supplied with your smart device.

Wired Network Connection

If your wireless router (access point) does not support WPS, you can connect the Disklavier to a wireless router (access point) using an Ethernet cable.

- 1** Press the POWER  button to turn the power off.
- 2** (For grand pianos) Connect the wireless router (access point) to the LAN port on the control center unit using an Ethernet cable.

(Grand piano)

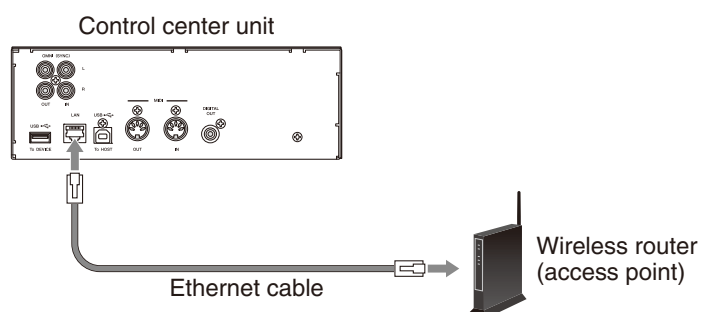

(For upright pianos) Connect the wireless router (access point) to the LAN port on the inlet box using an Ethernet cable.

(Upright piano)

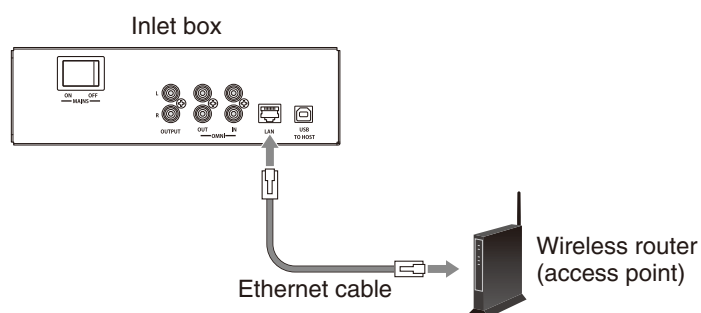

- 3** Enable the DHCP server function on the wireless router (access point).

Note:

The inlet box is located on the rear of the piano.

Note:

For details on the DHCP setting, refer to the owner's manual supplied with your wireless router (access point).

4 Press the POWER button to turn the power on.

Connection between the Disklavier and the wireless router (access point) is automatically established in approximately 15 to 20 seconds.

5 Open the Wi-Fi setting screen on your smart device.

6 Enable the Wi-Fi function.

7 From the network list shown on the screen, tap on the network to which you connected your Disklavier.

If necessary, enter a password, and then connect.

Note:

For details on the Wi-Fi setting, refer to the owner's manual supplied with your smart device.

Direct Wireless Connection

You can use the Disklavier as an access point to establish a direct wireless connection between the Disklavier and your smart device.

1 Press the POWER button to turn the power off.

2 Connect the USB wireless LAN adaptor (UD-WL01) to the USB port on the rear of the switch box.

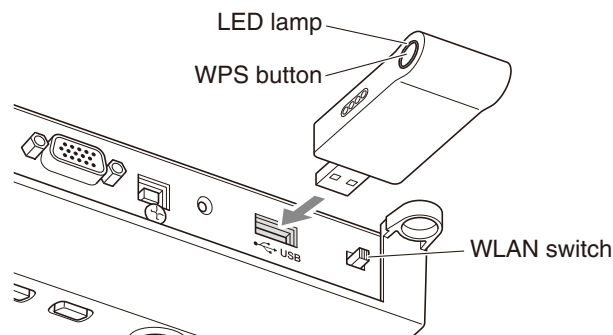

3 Set the WLAN switch on the rear of the switch box to "AP."



Note:

If the Disklavier is connected directly to your smart device, no Internet access is available on your smart device.

Note:

As a default, the WLAN switch is set to the "RT" position.

Getting Started

4 Press the POWER button to turn the power on.

When the Disklavier is set as an access point, the LED lamp on the USB wireless LAN adaptor (UD-WL01) lights up.

Now your Disklavier is available as an access point.

5 Open the Wi-Fi setting screen on your smart device.

6 Enable the Wi-Fi function.

7 From the network list shown on the screen, tap on [DKV*****].

Note:

For details on the Wi-Fi setting, refer to the owner's manual supplied with your smart device.

Note:

[DKV*****] differs depending on each Disklavier.

Using the ENSPIRE Controller App

■ Installing the App

To connect your smart device to the Disklavier, you must install the ENSPIRE Controller app to your smart device.

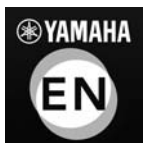

For details, search for "ENSPIRE Controller" on the App Store or Google Play.

■ Connecting Your Smart Device to the Disklavier

After you have connected your smart device to a network, open the ENSPIRE Controller app and select the Disklavier from the list. Tapping the Disklavier name will open the control screen of that Disklavier.

Note:

- The application supports iOS and Android devices.
- For details on the application, refer to the description on the download site.

IDC Registration

To use the IDC service, initial registration is required using an Internet-connected computer.

Please register at the following website:

<https://member.yamaha.com/myproduct/regist/>

Once you have an IDC account, you will interact with that account using the ENSPIRE Controller app. To use the full IDC service, you are required to enter your registered ID (e-mail address) and password on the ENSPIRE Controller app.

Note:

- If you have already registered for the IDC service with any other instrument, you do not need to register again. You can use your ID and password obtained through that registration.
- Some IDC service functions do not require an ID and password.

Updating the Disklavier

You can update the Disklavier firmware using USB flash memory.

1 Download the update program file.

You can download the update program from the following site:
<http://download.yamaha.com/>

2 Copy “en_update.bin” included in the downloaded file to the root directory of the USB flash memory.

3 Press the POWER button to turn the power off.

4 Connect the USB flash memory to the USB port on the front of the switch box.

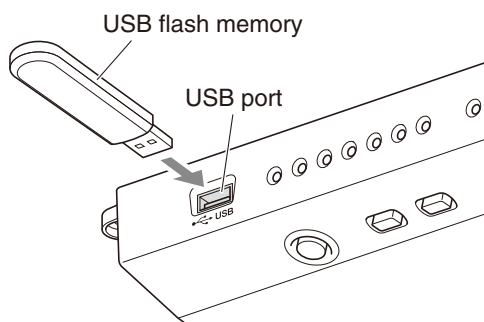

5 Holding the PLAY/PAUSE button, press the POWER button.

The POWER  indicator flashes, and the Disklavier enters the update mode.

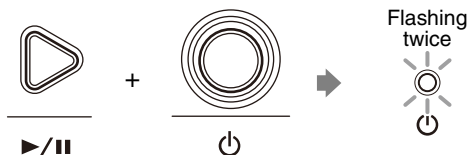

If any available update program is detected, the Disklavier starts to update. The update progress is indicated with the VOLUME indicators.



When the update is complete, the Disklavier restarts automatically. After the Disklavier restarts, check the firmware version using the ENSPIRE Controller app.

Note:

- To update your Disklavier, you will need a USB flash memory with 2GB or more of free space.
- You can also update your Disklavier using the ENSPIRE Controller app. To update your Disklavier using the app, Internet connection is required.

Note:

It is recommended that the USB flash memory only contains the update program file.

Important:

DO NOT turn the power off or disconnect the USB flash memory during update.

Initializing Network Settings

If the ENSPIRE Controller app cannot connect to your Disklavier due to the improper network settings, follow the procedure below to initialize network settings on your Disklavier.

1 Press the POWER  button to turn the power off.

2 Holding the VOLUME +/- buttons, press the POWER  button.



After the unit is turned on, restart the ENSPIRE Controller app.

Troubleshooting

If you are having difficulty operating the Disklavier, see if any of the symptoms listed below apply to your problem and follow the recommended remedy.

Power

Symptom	Remedy
The Disklavier does not turn on.	<p>Make sure that the main switch on the power supply unit is turned on.</p> <p>Make sure that the AC power cable is securely connected to a suitable AC wall outlet.</p> <p>If the Disklavier still cannot be turned on, disconnect it from the AC wall outlet, and consult your Disklavier dealer.</p>

Switch Box

Symptom	Remedy
The switch box does not appear to work correctly.	Turn off the switch box, wait 5 seconds, then turn it back on. If the problem continues, consult your Disklavier dealer.
The switch box becomes hot.	The chassis of the switch box may become hot depending on usage conditions.

Monitor Speaker

Symptom	Remedy
No sound is heard from the monitor speaker.	<p>Make sure that the POWER switch on the monitor speaker is turned on.</p> <p>Make sure that the monitor speaker is connected to the OUTPUT jacks on the control center unit with the supplied speaker cord.</p> <p>Make sure that the overall volume is adequately turned up.</p> <p>Make sure that the volume of the internal tone generator, audio and voice are adequately turned up.</p>

Playback

Symptom	Remedy
The Disklavier does not read a song file.	Make sure that the name of the SMF song has the extension of ".mid" and the audio song has ".wav" or ".mp3."
Some notes drop out during playback.	When a piano song is played back at a low volume, complex note trills and faint pianissimo passages sometimes drop out. In such cases, increase the Disklavier's volume level.

Network

Symptom	Remedy
The Disklavier cannot connect to the Internet via a wireless router (access point).	<p>Make sure that the wireless router (access point) is turned on.</p> <hr/> <p>The Disklavier and the wireless router (access point) might be too far apart. Place the Disklavier and the wireless router (access point) closer to each other.</p> <hr/> <p>There might be an obstacle between the Disklavier and the wireless router (access point). Move the wireless router (access point) to a location where there are no obstacles between them.</p> <hr/> <p>If you connect the Disklavier and the wireless router (access point) using an Ethernet cable, enable the DHCP server function on your wireless router (access point).</p>
Wireless network is not found.	<p>Microwave ovens or other wireless devices in your network area might disturb the wireless communication. Turn off these devices.</p> <hr/> <p>Access to the network is restricted by the firewall settings of the wireless router (access point). Check the firewall setting of the wireless router (access point).</p>
The ENSPIRE Controller app does not detect the Disklavier.	<p>The Disklavier and smart device are not on the same network. Check the network connections and settings on the wireless router (access point), and then connect the Disklavier and smart device to the same network.</p>

Error Indications

The error indicator may flash in red when some error has occurred. Refer to the table below for an explanation of the indication.

Example of Indication:

Flashing



Lighting up



Indication	Situation	Remedy
	Firmware update is failed.	Turn the power off. Download the update program and try to update the firmware again. If the problem still persists, consult your Yamaha piano dealer.
	Two or more USB flash memories are connected at the same time.	You can use only one USB flash memory at a time. Disconnect the other USB flash memory.
	The USB flash memory is protected.	Unprotect the USB flash memory.
	The wireless router (access point) is not found.	Make sure that the wireless router (access point) is turned on. If you connect the Disklavier and the wireless router (access point) using an Ethernet cable, make sure that the cable is firmly connected to the wireless router (access point).
	The Disklavier cannot obtain the IP address.	Check the settings of your network devices.
	The piano control unit does not work properly.	Consult your Yamaha piano dealer. If you are using the ENSPIRE Controller app, please tell them the message on the screen.

- Error message also appears on the control screen of the ENSPIRE Controller app. To close the message, tap on “Close” on the pop-up.
- Pressing any of VOLUME +/- or PLAY/PAUSE buttons turns off the error indicator, and the VOLUME indicators return to the previous status.

Glossary

This glossary provides basic definitions of terms used frequently in Disklavier manuals.

DHCP

This is a standard or protocol by which IP addresses and other low-level network configuration information can be dynamically and automatically assigned each time a connection is made to the Internet.

Ensemble Song

A song which contains piano parts and accompanying instrumental voices. An ensemble song contains the same left- and right-hand parts as an L/R song, and in addition, up to 13 accompanying instrument tracks. These extra tracks are played by the internal XG tone generator. The accompanying tracks may be used for acoustic bass, drums, strings, vibes, etc.

General MIDI (GM)

An addition to the MIDI standard that simplifies the transfer of MIDI song files between instruments of different manufacturers. A MIDI song recorded using a GM compatible tone generator should play back correctly when used with any GM compatible tone generator. The standard specifies that a GM compatible tone generator must support 24-note polyphony, 16 parts, and 128 standard voices.

Incremental Pedal

Piano pedals are not always completely up or down and may be held somewhere in-between. Using incremental pedal data (also called continuous or half pedal data) the Disklavier precisely records the up and down movement of the piano pedals.

Internet

A huge network made up of networks, the Internet allows high-speed data transfer among computers, mobile phones and other devices.

ISP (Internet Service Provider)

A communications business that offers Internet connection services. In order to connect to the Internet, it is necessary to have active service with an Internet service provider.

LAN

Short for Local Area Network, this is a data-transfer network that connects a group of computers at a single location (such as an office or home) by means of a special cable.

L/R Song

In a L/R song, the left-hand piano part is stored on track 1 (L) and the right-hand piano part is stored on track 2 (R). During playback you can cancel either part, and then play that part yourself. When recording an L/R song, you can record the two parts simultaneously or separately.

MIDI

An acronym for Musical Instrument Digital Interface. MIDI allows electronic musical instruments to communicate with each other.

Piano Parts

Refer to the left- and right-hand piano parts of a song. The left-hand piano part is recorded onto track 1 and the right-hand piano part is recorded onto track 2.

PianoSoft™

PianoSoft software contains prerecorded songs made by Yamaha specifically for use with the Disklavier.

PianoSoftPlus™

PianoSoftPlus software contains Ensemble songs that can be played on the Disklavier.

Polyphony

The maximum number of voices (or sounds) that can be produced at a time from MIDI instruments.

Router

A device for connecting multiple computer networks. For example, a router is necessary when connecting several computers in a house or office, to allow all of them access the Internet and share data. A router is usually connected between a modem and a computer, although some modems have a built-in router.

SMF

Abbreviation for Standard MIDI File.

SMF Song Format

A song file format supported by MIDI sequencers and music software.

Song

Normally, a short piece of music with lyrics. However, for clarity in Disklavier manuals, the term is used to refer to any piece of music of any genre.

Standard MIDI File

A file of MIDI data that can be read and used by a number of different MIDI devices and computers.

Tone Generator

An electronic device that can generate tones or instrument voices.

USB

An interface for connecting an external “plug and play” device. The Disklavier is equipped with three TO DEVICE ports with USB 2.0 standard and one TO HOST port. An external storage device, such as USB flash memory, can be used with the Disklavier by connecting it to a TO DEVICE port. Also the Disklavier enables you to enjoy a variety of MIDI features by connecting a computer to TO HOST port.

Voice

The sounds produced by a tone generator expressing various instruments.

Wi-Fi

Wi-Fi (Wireless Fidelity) is a technology that allows an electronic device to exchange data or connect to the Internet wirelessly using radio waves. Wi-Fi offers the advantage of eliminating the complexity of making connections with network cables by using wireless connection. Only products that complete Wi-Fi Alliance interoperability tests can carry the “Wi-Fi Certified” trademark.

WPS

WPS (Wi-Fi Protected Setup) is a standard established by the Wi-Fi Alliance, which allows easy establishment of a wireless home network.

XG

Yamaha XG is an extension of the GM (General MIDI) format. Its greater polyphony, more voices, and use of effects enhances the compatibility between MIDI devices. When a song in the Yamaha XG format is played on another XG-compatible tone generator or synthesizer, it plays and sounds as the original composer/creator intended.

General Specifications

Type		ST		PRO
Piano		Grand Piano	Upright Piano	Grand Piano
Sensor System	Key Sensors	Non-contact optical fiber grayscale shutter sensing system for 88 keys (sensors for the key position, keying velocity, and key releasing velocity)		
	Hammer Sensors	Non-contact optical fiber/shutter sensing system ^{*1}		Non-contact optical fiber/grayscale sensing system
	Pedal Sensors	Damper & shift pedals: Non-contact optical position-sensing system Sostenuto pedal: ON/OFF detection sensing system	Damper & soft pedals: Non-contact optical position-sensing system	Damper & shift pedals: Non-contact digital optical position-sensing system Sostenuto pedal: ON/OFF detection sensing system
Drive System	Key Drive	DSP servo drive system (servo-controlled solenoids, key sensor feedback)		DSP servo drive system (high-power servo-controlled solenoids with supersensitive magnetic sensor, key/hammer sensor feedback)
	Pedal Drive	DSP servo drive system (servo-controlled solenoids)		
Silencing System		Motor-driven hammer shank stopper		
Compatible Storage Media		USB flash memory		
Built-in Songs		500 songs		
Compatible File Formats		Standard MIDI File (SMF) format 0, Standard MIDI File (SMF) format 1, WAV, MP3		
Compatible Song Formats		PianoSoft, PianoSoftPlus, PianoSoftAudio, SmartKey		
Switch Box	Buttons	POWER  , VOLUME -/+, PLAY/PAUSE, MAINTENANCE		
	Switches	AUTO PLAY, AUTO OFF MODE, WLAN		
	Dimension (W x D x H)	220 x 70 x 30 mm (8-11/16 x 2-3/4 x 1-3/16 inch)		
Control Center Unit	Dimension (W x D x H)	224 x 130 x 76 mm (8-13/16 x 5-1/8 x 3 inch)		
Connectors	MIDI	MIDI IN, MIDI OUT	—	MIDI IN, MIDI OUT
	Audio	OUTPUT, OMNI (SYNC) IN, OMNI (SYNC) OUT, DIGITAL OUT, HEADPHONE (mini)	OUTPUT, OMNI (SYNC) IN, OMNI (SYNC) OUT, HEADPHONE (mini)	OUTPUT, OMNI (SYNC) IN, OMNI (SYNC) OUT, DIGITAL OUT, HEADPHONE (mini)
	Others	LAN, USB (To HOST x 1, To DEVICE x 3)	LAN, USB (To HOST x 1, To DEVICE x 2)	LAN, USB (To HOST x 1, To DEVICE x 3)

Type	ST		PRO
Piano	Grand Piano	Upright Piano	Grand Piano
Tone Generator	Piano Sound	CFX Binaural Sampling, CFX Stereo Sampling	
	Pitch Control	414.8 Hz to 466.8 Hz (tunable in 0.2 Hz increments)	
	Polyphony	256 notes (max.)	
	Voices for Playing	16 voices (Piano, Electric Piano 1, Electric Piano 2, Electric Piano 3, Harpsichord 1, Harpsichord 2, Vibraphone, Celesta, Pipe Organ 1, Pipe Organ 2, Pipe Organ 3, Pipe Organ 4, Jazz Organ, Strings, Choir, Synth Pad)	
	Voice Module Modes	XG, GM	
	Normal Voices	480 voices	
	Drum Kits	12 kits	
Power Source	AC 100 V to 240 V, 50/60 Hz		
Supplied Accessories	Monitor speaker (2) ^{*2} , Monitor speaker installation kit (2) ^{*2} , Stereo headphones (1), Owner's manual (1), Built-in song list (1), Music book "50 greats for the Piano" (1), USB wireless LAN adaptor (1)	Stereo headphones (1), Owner's manual (1), Built-in song list (1), Music book "50 greats for the Piano" (1), USB wireless LAN adaptor (1)	Monitor speaker (2) ^{*2} , Monitor speaker installation kit (2) ^{*2} , Stereo headphones (1), Owner's manual (1), Built-in song list (1), Music book "50 greats for the Piano" (1), USB wireless LAN adaptor (1)

Specifications are subject to change without prior notice.

^{*1} Not equipped on some models.

^{*2} Not supplied on some models.

disklavier **ENSPIRE™**
ST/PRO

Appendix

XG Voice List

Voice Group	Voice Name	MSB	LSB	PRG	Element	
Piano	GrandPiano	0	0	1	2*	
	GrndPianoKSP	0	1	1	1	
	MellowGrPno	0	18	1	2	
	PianoStrings	0	40	1	2	
	Dream	0	41	1	2	
	BrightPiano	0	0	2	2	
	BritePnoKSP	0	1	2	1	
	ElecGrandPno	0	0	3	2	
	ElecGrPnoKSP	0	1	3	2	
	DetunedCP80	0	32	3	2	
	LayeredCP1	0	40	3	2	
	LayeredCP2	0	41	3	2	
	Honkytonk	0	0	4	2	
	HonkytonkKSP	0	1	4	2	
	El.Piano1	0	0	5	2	
	El.Piano1KSP	0	1	5	1	
	MellowEP1	0	18	5	2	
	ChorusEP1	0	32	5	2	
	HardEl.Piano	0	40	5	2	
	VXfadeEl.P1	0	45	5	2	
	60sEl.Piano1	0	64	5	1	
	El.Piano2	0	0	6	2	
	El.Piano2KSP	0	1	6	1	
	ChorusEP2	0	32	6	2	
	DXEPHard	0	33	6	2	
	DXLegend	0	34	6	2	
	DXPhaseEP	0	40	6	2	
	DX+AnalogEP	0	41	6	2	
	DXKotoEP	0	42	6	2	
	VXfadeEl.P2	0	45	6	2	
	Harpsichord	0	0	7	1	
	Harpsi.KSP	0	1	7	1	
	Harpsichord2	0	25	7	2	
	Harpsichord3	0	35	7	2	
	Clavi.	0	0	8	1	
	Clavi.KSP	0	1	8	1	
	Clavi.Wah	0	27	8	2	
	PulseClavi.	0	64	8	1	
	PierceClavi.	0	65	8	2	
	Chromatic Percussion	Celesta	0	0	9	1
		Glockenspiel	0	0	10	1
		MusicBox	0	0	11	2
		Orgel	0	64	11	2
		Vibraphone	0	0	12	1
		VibesKSP	0	1	12	1
		HardVibes	0	45	12	2
		Marimba	0	0	13	1
		MarimbaKSP	0	1	13	1
		SineMarimba	0	64	13	2
		Balimba	0	97	13	2
		LogDrums	0	98	13	2
		Xylophone	0	0	14	1
		TubularBells	0	0	15	1
		ChurchBells	0	96	15	2
		Carillon	0	97	15	2
		Dulcimer	0	0	16	1
Dulcimer2		0	35	16	2	
Cimbalom		0	96	16	2	
Santur		0	97	16	2	
Organ	DrawbarOrgan	0	0	17	1	
	DetDrawOrgan	0	32	17	2	
	60sDrawOrg1	0	33	17	2	
	60sDrawOrg2	0	34	17	2	
	70sDrawOrg1	0	35	17	2	
	DrawbarOrg2	0	36	17	2	
	60sDrawOrg3	0	37	17	2	
	EvenBarOrg	0	38	17	2	
	16+2*2_3Org	0	40	17	2	
	OrganBass	0	64	17	1	
	70sDrawOrg2	0	65	17	2	
	CheezyOrgan	0	66	17	2	
	DrawbarOrg3	0	67	17	2	
	Perc.Organ	0	0	18	1	
	70sPercOrg1	0	24	18	2	
	DetPercOrgan	0	32	18	2	
	LightOrgan	0	33	18	2	

* The number of elements becomes 4 when the damper pedal is pressed.

Voice Group	Voice Name	MSB	LSB	PRG	Element
Organ	Perc.Organ2	0	37	18	2
	RockOrgan	0	0	19	1
	RotaryOrgan	0	64	19	2
	SlowRotary	0	65	19	2
	FastRotary	0	66	19	2
	ChurchOrgan	0	0	20	2
	ChurchOrgan3	0	32	20	2
	ChurchOrgan2	0	35	20	2
	NotreDame	0	40	20	2
	OrganFlute	0	64	20	2
	Trem.OrganFl	0	65	20	2
	ReedOrgan	0	0	21	1
	PuffOrgan	0	40	21	2
	Accordion	0	0	22	1
	AccordIt	0	32	22	2
	Harmonica	0	0	23	1
	Harmonica2	0	32	23	2
	TangoAccord	0	0	24	1
	TangoAccord2	0	64	24	2
	Guitar	NylonGuitar	0	0	25
NylonGuitar2		0	16	25	1
NylonGuitar3		0	25	25	2
VelGtrHarmo		0	43	25	1
Ukulele		0	96	25	1
SteelGuitar		0	0	26	1
SteelGuitar2		0	16	26	1
12StrGuitar		0	35	26	2
Nylon&Steel		0	40	26	2
Steel&Body		0	41	26	2
Mandolin		0	96	26	2
JazzGuitar		0	0	27	1
MellowGuitar		0	18	27	1
JazzAmp		0	32	27	2
CleanGuitar		0	0	28	1
ChorusGuitar		0	32	28	2
MutedGuitar		0	0	29	1
FunkGuitar1		0	40	29	2
MuteSteelGtr		0	41	29	2
FunkGuitar2		0	43	29	1
JazzMan		0	45	29	2
Overdriven		0	0	30	1
GuitarPinch		0	43	30	1
Distortion		0	0	31	1
FeedbackGtr		0	40	31	2
FeedbackGtr2		0	41	31	2
GtrHarmonics		0	0	32	1
GtrFeedback		0	65	32	1
GtrHarmonic2		0	66	32	1
Bass		AcousticBass	0	0	33
	JazzRhythm	0	40	33	2
	VXUprghtBass	0	45	33	2
	FingerBass	0	0	34	1
	FingerDark	0	18	34	2
	FlangeBass	0	27	34	2
	Bass&DistEG	0	40	34	2
	FingerSlap	0	43	34	1
	FingerBass2	0	45	34	2
	Mod.Bass	0	65	34	2
	PickBass	0	0	35	1
	MutePickBass	0	28	35	1
	FretlessBass	0	0	36	1
	Fretless2	0	32	36	2
	Fretless3	0	33	36	2
	Fretless4	0	34	36	2
	Syn.Fretless	0	96	36	2
	SmthFretless	0	97	36	2
	SlapBass1	0	0	37	1
	ResonantSlap	0	27	37	1
	PunchThumb	0	32	37	2
	SlapBass2	0	0	38	1
	Velo.Sw.Slap	0	43	38	1
	SynthBass1	0	0	39	1
	SynBass1Dark	0	18	39	1
	FastResoBass	0	20	39	1
	AcidBass	0	24	39	1
	ClaviBass	0	35	39	2

XG Voice List

Voice Group	Voice Name	MSB	LSB	PRG	Element	
Bass	TechnoBass	0	40	39	2	
	Orbiter	0	64	39	2	
	SquareBass	0	65	39	1	
	RubberBass	0	66	39	2	
	Hammer	0	96	39	2	
	SynthBass2	0	0	40	2	
	MellowSyBass	0	6	40	1	
	SequenceBass	0	12	40	2	
	ClickSynBass	0	18	40	2	
	SynBass2Dark	0	19	40	1	
	SmoothSyBass	0	32	40	2	
	ModulrSyBass	0	40	40	2	
	DXBass	0	41	40	2	
	XWireBass	0	64	40	2	
Strings	Violin	0	0	41	1	
	SlwAtkViolin	0	8	41	1	
	Viola	0	0	42	1	
	Cello	0	0	43	1	
	Contrabass	0	0	44	1	
	Trem.Strings	0	0	45	1	
	SlwAtkTremStr	0	8	45	1	
	SuspenseStr	0	40	45	2	
	PizzicatoStr	0	0	46	1	
	Orch.Harp	0	0	47	1	
	YangChin	0	40	47	2	
	Timpani	0	0	48	1	
	Ensemble	Strings1	0	0	49	1
		StereoStrngs	0	3	49	2
SlwAtkStrngs		0	8	49	1	
ArcoStrings		0	24	49	2	
60'sStrings		0	35	49	2	
Orchestra		0	40	49	2	
Orchestra2		0	41	49	2	
TremOrchestra		0	42	49	2	
Velo.Strings		0	45	49	2	
Strings2		0	0	50	1	
S.SlowStrngs		0	3	50	2	
LegatoStrngs		0	8	50	2	
WarmStrings		0	40	50	2	
Kingdom		0	41	50	2	
70'sStrings		0	64	50	1	
Strings3		0	65	50	1	
SynStrings1		0	0	51	2	
ResoStrings		0	27	51	2	
SynStrings4		0	64	51	2	
SynStrings5		0	65	51	2	
SynStrings2		0	0	52	2	
ChoirAahs		0	0	53	1	
StereoChoir		0	3	53	2	
ChoirAahs2		0	16	53	2	
MellowChoir		0	32	53	2	
ChoirStrings		0	40	53	2	
VoiceOohs		0	0	54	1	
SynthVoice		0	0	55	1	
SynthVoice2		0	40	55	2	
Choral		0	41	55	2	
AnalogVoice		0	64	55	1	
OrchestraHit		0	0	56	2	
OrchestrHit2		0	35	56	2	
Impact	0	64	56	2		
Brass	Trumpet	0	0	57	1	
	Trumpet2	0	16	57	1	
	BriteTrumpet	0	17	57	2	
	WarmTrumpet	0	32	57	2	
	Trombone	0	0	58	1	
	Trombone2	0	18	58	2	
	Tuba	0	0	59	1	
	Tuba2	0	16	59	1	
	MutedTrumpet	0	0	60	1	
	FrenchHorn	0	0	61	1	
	Fr.HornSolo	0	6	61	1	
	FrenchHorn2	0	32	61	2	
	HornOrchestr	0	37	61	2	
	BrassSection	0	0	62	1	
	Tp&TbSection	0	35	62	2	
	BrassSect2	0	40	62	2	
	HighBrass	0	41	62	2	
	MellowBrass	0	42	62	2	
	SynthBrass1	0	0	63	2	
	QuackBrass	0	12	63	2	
	ResoSynBrass	0	20	63	2	
	PolyBrass	0	24	63	2	

Voice Group	Voice Name	MSB	LSB	PRG	Element	
Brass	SynthBrass3	0	27	63	2	
	JumpBrass	0	32	63	2	
	AnaVelBrass1	0	45	63	2	
	AnalogBrass1	0	64	63	2	
	SynthBrass2	0	0	64	1	
	SoftBrass	0	18	64	2	
	SynthBrass4	0	40	64	2	
	ChoirBrass	0	41	64	2	
	AnaVelBrass2	0	45	64	2	
	AnalogBrass2	0	64	64	2	
Reed	SopranoSax	0	0	65	1	
	AltoSax	0	0	66	1	
	SaxSection	0	40	66	2	
	HyperAltoSax	0	43	66	1	
	TenorSax	0	0	67	1	
	BreathyTenor	0	40	67	2	
	SoftTenorSax	0	41	67	2	
	TenorSax2	0	64	67	1	
	BaritoneSax	0	0	68	1	
	Oboe	0	0	69	1	
	EnglishHorn	0	0	70	1	
	Bassoon	0	0	71	1	
	Clarinet	0	0	72	1	
	Pipe	Piccolo	0	0	73	1
Flute		0	0	74	1	
Recorder		0	0	75	1	
PanFlute		0	0	76	1	
BlownBottle		0	0	77	2	
Shakuhachi		0	0	78	1	
Whistle		0	0	79	1	
Ocarina		0	0	80	1	
Synth. Lead		SquareLead	0	0	81	2
		SquareLead2	0	6	81	1
	LMSquare	0	8	81	2	
	Hollow	0	18	81	1	
	Shroud	0	19	81	2	
	Mellow	0	64	81	2	
	SoloSine	0	65	81	2	
	SineLead	0	66	81	1	
	SawtoothLead	0	0	82	2	
	SawtoothLd2	0	6	82	1	
	ThickSaw	0	8	82	2	
	DynamicSaw	0	18	82	1	
	DigitalSaw	0	19	82	2	
	BigLead	0	20	82	2	
	HeavySynth	0	24	82	2	
	WaspySynth	0	25	82	2	
	PulseSaw	0	40	82	2	
	Dr.Lead	0	41	82	2	
	VelocityLead	0	45	82	2	
	Seq.Analog	0	96	82	2	
	CalliopeLead	0	0	83	2	
	PureLead	0	65	83	2	
	ChiffLead	0	0	84	2	
	Rubby	0	64	84	2	
	CharangLead	0	0	85	2	
	DistortedLd	0	64	85	2	
	WireLead	0	65	85	2	
	VoiceLead	0	0	86	2	
	SynthAahs	0	24	86	2	
	VoxLead	0	64	86	2	
	FifthsLead	0	0	87	2	
	BigFive	0	35	87	2	
	Bass&Lead	0	0	88	2	
	Big&Low	0	16	88	2	
	Fat&Perky	0	64	88	2	
	SoftWhirl	0	65	88	2	
	Synth. Pad	NewAgePad	0	0	89	2
		Fantasy	0	64	89	2
		WarmPad	0	0	90	2
		ThickPad	0	16	90	2
		SoftPad	0	17	90	2
		SinePad	0	18	90	2
HornPad		0	64	90	2	
RotaryStrngs		0	65	90	2	
PolySynthPad		0	0	91	2	
PolyPad80		0	64	91	2	
ClickPad		0	65	91	2	
AnalogPad		0	66	91	2	
SquarePad		0	67	91	2	
ChoirPad		0	0	92	2	
Heaven	0	64	92	2		

Voice Group	Voice Name	MSB	LSB	PRG	Element	
Synth. Pad	Itopia	0	66	92	2	
	CCPad	0	67	92	2	
	BowedPad	0	0	93	2	
	Glacier	0	64	93	2	
	GlassPad	0	65	93	2	
	MetallicPad	0	0	94	2	
	TinePad	0	64	94	2	
	PanPad	0	65	94	2	
	HaloPad	0	0	95	2	
	SweepPad	0	0	96	2	
	Shwimmer	0	20	96	2	
	Converge	0	27	96	2	
	PolarPad	0	64	96	2	
	Celestial	0	66	96	2	
	Synth. Effects	Rain	0	0	97	2
		ClaviPad	0	45	97	2
		HarmoRain	0	64	97	2
AfricanWind		0	65	97	2	
Carib		0	66	97	2	
SoundTrack		0	0	98	2	
Prologue		0	27	98	2	
Ancestral		0	64	98	2	
Crystal		0	0	99	2	
SynthDr.Comp		0	12	99	2	
Popcorn		0	14	99	2	
TinyBells		0	18	99	2	
RoundGlocken		0	35	99	2	
GlockenChime		0	40	99	2	
ClearBells		0	41	99	2	
ChorusBells		0	42	99	2	
SynthMallet		0	64	99	1	
SoftCrystal		0	65	99	2	
LoudGlocken		0	66	99	2	
ChristmasBel		0	67	99	2	
VibeBells		0	68	99	2	
DigitalBells		0	69	99	2	
AirBells		0	70	99	2	
BellHarp		0	71	99	2	
Gamelimba		0	72	99	2	
Atmosphere		0	0	100	2	
WarmAtmos.		0	18	100	2	
HollwRelease		0	19	100	2	
NylonElPiano		0	40	100	2	
NylonHarp		0	64	100	2	
HarpVox		0	65	100	2	
Atmos.Pad		0	66	100	2	
Planet		0	67	100	2	
Brightness		0	0	101	2	
FantasyBells		0	64	101	2	
Smockey		0	96	101	2	
Goblins		0	0	102	2	
GoblinsSynth		0	64	102	2	
Creeper		0	65	102	2	
RingPad		0	66	102	2	
Ritual		0	67	102	2	
ToHeaven		0	68	102	2	
Night		0	70	102	2	
Glisten		0	71	102	2	
BellChoir		0	96	102	2	
Echoes		0	0	103	2	
Echoes2		0	8	103	2	
EchoPan		0	14	103	2	
EchoBells		0	64	103	2	
BigPan		0	65	103	2	
SynthPiano	0	66	103	2		
Creation	0	67	103	2		
StarDust	0	68	103	2		
Reso&Panning	0	69	103	2		
Sci-Fi	0	0	104	2		
Starz	0	64	104	2		
Ethnic	Sitar	0	0	105	1	
	DetunedSitar	0	32	105	2	
	Sitar2	0	35	105	2	
	Tambra	0	96	105	2	
	Tamboura	0	97	105	2	
	Banjo	0	0	106	1	
	MutedBanjo	0	28	106	1	
	Rabab	0	96	106	2	
	Gopichant	0	97	106	2	
	Oud	0	98	106	2	
	Shamisen	0	0	107	1	
	Koto	0	0	108	1	

Voice Group	Voice Name	MSB	LSB	PRG	Element	
Ethnic	Taisho-kin	0	96	108	2	
	Kanoon	0	97	108	2	
	Kalimba	0	0	109	1	
	Bagpipe	0	0	110	2	
	Fiddle	0	0	111	1	
	Shanai	0	0	112	1	
	Shanai2	0	64	112	1	
	Pungi	0	96	112	1	
	Hichiriki	0	97	112	2	
	Percussive	TinkleBell	0	0	113	2
		Bonang	0	96	113	2
		Altair	0	97	113	2
		GamelanGongs	0	98	113	2
		StereoGamlan	0	99	113	2
		RamaCymbal	0	100	113	2
		AsianBells	0	101	113	2
		Agogo	0	0	114	2
SteelDrums		0	0	115	1	
GlassPerc.		0	97	115	2	
ThaiBells		0	98	115	2	
Woodblock		0	0	116	1	
Castanets		0	96	116	1	
TaikoDrum		0	0	117	1	
GranCassa		0	96	117	1	
MelodicTom		0	0	118	2	
MelodicTom2		0	64	118	1	
RealTom		0	65	118	2	
RockTom		0	66	118	2	
SynthDrum		0	0	119	1	
AnalogTom		0	64	119	1	
ElectroPerc.		0	65	119	2	
Rev.Cymbal		0	0	120	1	
Sound Effects	GtrFretNoise	0	0	121	1	
	BreathNoise	0	0	122	1	
	Seashore	0	0	123	2	
	BirdTweet	0	0	124	2	
	TelephonRing	0	0	125	1	
	Helicopter	0	0	126	1	
	Applause	0	0	127	1	
	Gunshot	0	0	128	1	
	SFX	CuttingNoise	64	0	1	1
		CuttingNoiz2	64	0	2	2
StringSlap		64	0	4	1	
Fl.KeyClick		64	0	17	1	
Shower		64	0	33	1	
Thunder		64	0	34	1	
Wind		64	0	35	1	
Stream		64	0	36	2	
Bubble		64	0	37	2	
Feed		64	0	38	2	
Dog		64	0	49	1	
Horse		64	0	50	1	
BirdTweet2		64	0	51	1	
Ghost		64	0	55	2	
Maou		64	0	56	2	
PhoneCall		64	0	65	1	
DoorSqueak		64	0	66	1	
DoorSlam		64	0	67	1	
ScratchCut		64	0	68	1	
ScratchSplit		64	0	69	2	
WindChime		64	0	70	1	
TelphonRing2		64	0	71	1	
CarEngineIgn		64	0	81	1	
CarTiresSql		64	0	82	1	
CarPassing		64	0	83	1	
CarCrash		64	0	84	1	
Siren		64	0	85	2	
Train		64	0	86	1	
JetPlane		64	0	87	2	
Starship		64	0	88	2	
Burst		64	0	89	2	
RollrCoaster		64	0	90	2	
Submarine		64	0	91	1	
Laugh		64	0	97	1	
Scream	64	0	98	1		
Punch	64	0	99	1		
Heartbeat	64	0	100	1		
FootSteps	64	0	101	1		
MachineGun	64	0	113	1		
LaserGun	64	0	114	2		
Explosion	64	0	115	2		
Firework	64	0	116	2		

XG Drum Kit List

☐ : Same as Standard Kit 1

☐ : No Sound

MIDI		Key Off	Alternate Group	Program Change					
Note #	Note			Standard Kit1	Standard Kit2	Room Kit	Rock Kit	Electro Kit	Analog Kit
Bank Select MSB (0-127)				127	127	127	127	127	127
Bank Select LSB (0-127)				0	0	0	0	0	0
Program Change (0-127)				0	1	8	16	24	25
Program Change (1-128)				1	2	9	17	25	26
13	C#-1		3	Surdo Mute					
14	D-1		3	Surdo Open					
15	D#-1			Hi Q					
16	E-1			Whip Slap					
17	F-1		4	Scratch H					
18	F#-1		4	Scratch L					
19	G-1			Finger Snap					
20	G#-1			Click Noise					
21	A-1			Metronome Click					
22	A#-1			Metronome Bell					
23	B-1			Seq Click L					
24	C0			Seq Click H					
25	C#0			Brush Tap					
26	D0	○		Brush Swirl					
27	D#0			Brush Slap					
28	E0	○		Brush Tap Swirl				Reverse Cymbal	Reverse Cymbal
29	F0	○		Snare Roll					
30	F#0			Castanet				Hi Q 2	Hi Q 2
31	G0			Snare Soft	Snare Soft 2		Snare Noisy	Snare Snappy Electro	Snare Noisy 4
32	G#0			Sticks					
33	A0			Kick Soft				Kick 3	Kick 3
34	A#0			Open Rim Shot	Open Rim Shot H Short				
35	B0			Kick Tight			Kick 2	Kick Gate	Kick Analog Short
36	C1			Kick	Kick Shot		Kick Gate	Kick Gate Heavy	Kick Analog
37	C#1			Side Stick	Side Stick Light				Side Stick Analog
38	D1			Snare	Snare Short	Snare Snappy	Snare Rock	Snare Noisy 2	Snare Analog
39	D#1			Hand Clap					
40	E1			Snare Tight	Snare Tight H	Snare Tight Snappy	Snare Rock Tight	Snare Noisy 2	Snare Analog 2
41	F1			Floor Tom L		Tom Room 1	Tom Room 1	Tom Electro 1	Tom Analog 1
42	F#1		1	Hi-Hat Closed					Hi-Hat Closed Analog
43	G1			Floor Tom H		Tom Room 2	Tom Room 2	Tom Electro 2	Tom Analog 2
44	G#1		1	Hi-Hat Pedal					Hi-Hat Closed Analog 2
45	A1			Low Tom		Tom Room 3	Tom Room 3	Tom Electro 3	Tom Analog 3
46	A#1		1	Hi-Hat Open					Hi-Hat Open Analog
47	B1			Mid Tom L		Tom Room 4	Tom Room 4	Tom Electro 4	Tom Analog 4
48	C2			Mid Tom H		Tom Room 5	Tom Room 5	Tom Electro 5	Tom Analog 5
49	C#2			Crash Cymbal 1					Crash Analog
50	D2			High Tom		Tom Room 6	Tom Room 6	Tom Electro 6	Tom Analog 6
51	D#2			Ride Cymbal 1					
52	E2			Chinese Cymbal					
53	F2			Ride Cymbal Cup					
54	F#2			Tambourine					
55	G2			Splash Cymbal					
56	G#2			Cowbell					Cowbell Analog
57	A2			Crash Cymbal 2					
58	A#2			Vibraslap					
59	B2			Ride Cymbal 2					
60	C3			Bongo H					
61	C#3			Bongo L					
62	D3			Conga H Mute					Conga Analog H
63	D#3			Conga H Open					Conga Analog M
64	E3			Conga L					Conga Analog L
65	F3			Timbale H					
66	F#3			Timbale L					
67	G3			Agogo H					
68	G#3			Agogo L					
69	A3			Cabasa					
70	A#3			Maracas					Maracas 2
71	B3	○		Samba Whistle H					
72	C4	○		Samba Whistle L					
73	C#4			Guiro Short					
74	D4	○		Guiro Long					
75	D#4			Claves					Claves 2
76	E4			Wood Block H					
77	F4			Wood Block L					
78	F#4			Cuica Mute				Scratch H 2	Scratch H 2
79	G4			Cuica Open				Scratch L 2	Scratch L 2
80	G#4		2	Triangle Mute					
81	A4		2	Triangle Open					
82	A#4			Shaker					
83	B4			Jingle Bells					
84	C5			Bell Tree					
85	C#5								
86	D5								
87	D#5								
88	E5								
89	F5								
90	F#5								
91	G5								

* Key Off: Keys marked with a circle stop sounding the instant they are released.

* Alternate Group: Playing any instrument within a numbered group will immediately stop the sound of any other instrument in the same group of the same number.

□ : Same as Standard Kit 1

■ : No Sound

MIDI				Dance Kit	Jazz Kit	Brush Kit	Symphony Kit	SFX Kit1	SFX Kit2
Note #	Note	Key Off	Alternate Group						
13	C#-1		3						
14	D-1		3						
15	D#-1								
16	E-1								
17	F-1		4						
18	F#-1		4						
19	G-1								
20	G#-1								
21	A-1								
22	A#-1								
23	B-1								
24	C0								
25	C#0								
26	D0	○							
27	D#0								
28	E0	○		Reverse Cymbal					
29	F0	○							
30	F#0			Hi Q 2					
31	G0			Snare Techno	Snare Jazz H	Brush Slap 2			
32	G#0								
33	A0			Kick Techno Q			Kick Soft 2		
34	A#0			Rim Gate		Open Rim Shot Light			
35	B0			Kick Techno L			Gran Cassa		
36	C1			Kick Techno	Kick Jazz	Kick Jazz	Gran Cassa Mute	Cutting Noise	Phone Call
37	C#1			Side Stick Analog	Side Stick Light	Side Stick Light		Cutting Noise 2	Door Squeak
38	D1			Snare Clap	Snare Jazz L	Brush Slap 3	Band Snare		Door Slam
39	D#1							String Slap	Scratch Cut
40	E1			Snare Dry	Snare Jazz M	Brush Tap 2	Band Snare 2		Scratch H 3
41	F1			Tom Analog 1		Tom Brush 1			Wind Chime
42	F#1		1	Hi-Hat Closed 3					Telephone Ring 2
43	G1			Tom Analog 2		Tom Brush 2			
44	G#1		1	Hi-Hat Closed Analog 3					
45	A1			Tom Analog 3		Tom Brush 3			
46	A#1		1	Hi-Hat Open 3					
47	B1			Tom Analog 4		Tom Brush 4			
48	C2			Tom Analog 5		Tom Brush 5			
49	C#2			Crash Analog			Hand Cymbal		
50	D2			Tom Analog 6		Tom Brush 6			
51	D#2						Hand Cymbal Short		
52	E2							Flute Key Click	Car Engine Ignition
53	F2								Car Tires Squeal
54	F#2								Car Passing
55	G2								Car Crash
56	G#2			Cowbell Analog					Siren
57	A2						Hand Cymbal 2		Train
58	A#2								Jet Plane
59	B2						Hand Cymbal 2 Short		Starship
60	C3								Burst
61	C#3								Roller Coaster
62	D3			Conga Analog H					Submarine
63	D#3			Conga Analog M					
64	E3			Conga Analog L					
65	F3								
66	F#3								
67	G3								
68	G#3								
69	A3							Shower	Laugh
70	A#3			Maracas 2				Thunder	Scream
71	B3	○						Wind	Punch
72	C4	○						Stream	Heart Beat
73	C#4							Bubble	Foot Steps
74	D4	○						Feed	
75	D#4			Claves 2					
76	E4								
77	F4								
78	F#4			Scratch H 2					
79	G4			Scratch L 2					
80	G#4		2						
81	A4		2						
82	A#4								
83	B4								
84	C5							Dog	Machine Gun
85	C#5							Horse	Laser Gun
86	D5							Bird Tweet 2	Explosion
87	D#5								Firework
88	E5								
89	F5								
90	F#5							Ghost	
91	G5							Maou	

* Key Off: Keys marked with a circle stop sounding the instant they are released.

* Alternate Group: Playing any instrument within a numbered group will immediately stop the sound of any other instrument in the same group of the same number.

MIDI Data Format

MIDI Channel Message (1)

MIDI Events	Status byte		1st Data byte		2nd Data byte		[MIDI (Silent)]							
	Status	Data (HEX)	Data (HEX)	Parameter	Data (HEX)	Parameter	MIDI Reception	MIDI Transmission						
							Song Part	Piano Playback Channel	Panel Operation	Song Playback	MIDI Input			
Key Off [GM1] [GM2]	8nH (n: Channel Number)	kk		Key Number (0-127)	vv	Velocity (0-127)	○	○	×	×	×			
Key On [GM1] [GM2]	9nH (n: Channel Number)	kk		Key Number (0-127)	vv	Key On: vv=1-127 Key Off: vv=0	○	○	×	×	×			
Control Change	BnH		0 (00H)	Bank Select MSB [GM2]	0 (00H) 64 (40H) 118 (76H) 119 (77H) 120 (78H) 121 (79H) 126 (7EH) 127 (7FH)	Normal SFX Voice GS Rhythm GS Normal GM2 Rhythm GM2 Normal SFX Kit Drum Kit	○	○	×	×	×			
			1 (01H)	Modulation [GM1] [GM2]	0-127 (00H...7FH)	Data	○	×	×	×	×	×		
			5 (05H)	Portamento Time [GM2]	0-127 (00H...7FH)	Data	○	×	×	×	×	×		
			6 (06H)	Data Entry MSB [GM2]	0-127 (00H...7FH)	Data	○	×	×	×	×	×		
			7 (07H)	Main Volume [GM1] [GM2]	0-127 (00H...7FH)	Data	○	○	×	×	×	×		
			10 (0AH)	Panpot [GM1] [GM2]	0-127 (00H...7FH)	L64...C...R63	○	×	×	×	×	×		
			11 (0BH)	Expression [GM1] [GM2]	0-127 (00H...7FH)	Data	○	×	×	×	×	×		
			32 (20H)	Bank Select LSB [GM2]	0-127 (00H...7FH)	Data	○	○	×	×	×	×		
			38 (26H)	Data Entry LSB [GM2]	0-127 (00H...7FH)	Data	○	×	×	×	×	×		
			64 (40H)	Damper [GM1] [GM2]	0-127 (00H...7FH)	Data	○	○	×	×	×	×		
			65 (41H)	Portamento [GM2]	0-127 (00H...7FH)	OFF: 0-63 ON: 64-127	○	×	×	×	×	×		
			66 (42H)	Sostenuto [GM2]	0-127 (00H...7FH)	OFF: 0-63 ON: 64-127	○	○	×	×	×	×		
			67 (43H)	Soft Pedal [GM2]	0-127 (00H...7FH)	OFF: 0-63 ON: 64-127	○	○	×	×	×	×		
			71 (47H)	Harmonic Content [GM2]	0-127 (00H...7FH)	-64...0...+63	○	×	×	×	×	×		
			72 (48H)	Release Time [GM2]	0-127 (00H...7FH)	-64...0...+63	○	×	×	×	×	×		
			73 (49H)	Attack Time [GM2]	0-127 (00H...7FH)	-64...0...+63	○	×	×	×	×	×		
			74 (4AH)	Brightness [GM2]	0-127 (00H...7FH)	-64...0...+63	○	×	×	×	×	×		
			75 (4BH)	Decay Time [GM2]	0-127 (00H...7FH)	-64...0...+63	○	×	×	×	×	×		
			76 (4CH)	Vibrate Rate [GM2]	0-127 (00H...7FH)	-64...0...+63	○	×	×	×	×	×		
			77 (4DH)	Vibrate Depth [GM2]	0-127 (00H...7FH)	-64...0...+63	○	×	×	×	×	×		
			78 (4EH)	Vibrate Delay [GM2]	0-127 (00H...7FH)	-64...0...+63	○	×	×	×	×	×		
			84 (54H)	Portamento Control	0-127 (00H...7FH)	Key no. (0-127)	○	×	×	×	×	×		
			91 (5BH)	Effect1 Depth (Reverb Send Level) [GM2]	0-127 (00H...7FH)	Data	○	×	×	×	×	×		
			93 (5DH)	Effect3 Depth (Chorus Send Level) [GM2]	0-127 (00H...7FH)	Data	○	×	×	×	×	×		
			94 (5EH)	Effect4 Depth (Variation Send Level)	0-127 (00H...7FH)	Data	○	×	×	×	×	×		
			96 (60H)	RPN Increment	— —	The data byte is ignored	○	×	×	×	×	×		
			97 (61H)	RPN Decrement	— —	The data byte is ignored	○	×	×	×	×	×		
			98 (62H)	NRPN LSB	0-127 (00H...7FH)	Data	○	×	×	×	×	×		
			99 (63H)	NRPN MSB	0-127 (00H...7FH)	Data	○	×	×	×	×	×		
			100 (64H)	RPN LSB [GM2]	0-127 (00H...7FH)	Data	○	×	×	×	×	×		
			101 (65H)	RPN MSB [GM2]	0-127 (00H...7FH)	Data	○	×	×	×	×	×		
			Mode Message	BnH (n: Channel Number)		120 (78H)	All Sound Off [GM2]	0 (00H)	Data	○	○	×	×	×
						121 (79H)	Reset All Controllers [GM1] [GM2]	0 (00H)	Data	○	○	×	×	×
						122 (7AH)	Local Control	0 (00h) 127 (7FH)	OFF ON	○	○	×	×	×
123 (7BH)	All Note Off [GM1] [GM2]	0 (00H)				Data	○	○	×	×	×			
124 (7CH)	Omni Off [GM2]	0 (00H)				Data	○	×	×	×	×			
125 (7DH)	Omni On [GM2]	0 (00H)				Data	○	×	×	×	×			
126 (7EH)	Mono [GM2]	0-16 (00H...10H)				Data	○	×	×	×	×			
127 (7FH)	Poly [GM2]	0 (00H)	Data	○	×	×	×	×						
Program Change [GM1] [GM2]	CnH (n: Channel Number)	pp (00H...7FH)	Voice Number (0-127)	— —	—	○	○	×	×	×				
Channel After Touch [GM1] [GM2]	DnH (n: Channel Number)	vv (00H...7FH)	Data	— —	—	○	×	×	×	×				
Polyphonic After Touch	AnH (n: Channel Number)	kk (00H...7FH)	Key Number (0-127)	vv (00H...7FH)	Data	○	○	×	×	×				
Pitch Bend Change [GM1] [GM2]	EnH (n: Channel Number)	cc (00H...7FH)	LSB	dd (00H...7FH)	MSB	○	×	×	×	×				
Realtime Message	F8H	MIDI Clock	—	—	—	—	×	×	×	×				
	FAH	Start	—	—	—	—	×	×	×	×				
	FBH	Continue	—	—	—	—	×	×	×	×				
	FCH	Stop	—	—	—	—	×	×	×	×				
	FEH	Active Sens [GM2]	—	—	—	—	○	○	×	×				
FFH	System Reset	—	—	—	—	×	×	×	×	×				

* For upright pianos (excluding some models), the sostenuto pedal information (Control Change 66) is not transmitted.

MIDI Channel Message (2)

Parameters Controlled by NRPN (Non-Registered Parameter Numbers)

NRPN		Data Entry		Parameter	Data Range	[MIDI (Silent)]				
MSB	LSB	MSB	LSB			MIDI Reception	MIDI Transmission			
						Song Part	Piano Playback Channel	Panel Operation	Song Playback	MIDI Input
01H	08H	mmH	---	Vibrato Rate	mm: 00H-40H-7FH (-64...0...+63)	○	×	×	×	×
01H	09H	mmH	---	Vibrato Depth	mm: 00H-40H-7FH (-64...0...+63)	○	×	×	×	×
01H	0AH	mmH	---	Vibrato Delay	mm: 00H-40H-7FH (-64...0...+63)	○	×	×	×	×
01H	20H	mmH	---	Low Pass Filter Cutoff Frequency	mm: 00H-40H-7FH (-64...0...+63)	○	×	×	×	×
01H	21H	mmH	---	Low Pass Filter Resonance	mm: 00H-40H-7FH (-64...0...+63)	○	×	×	×	×
01H	30H	mmH	---	EQ BASS	mm: 00H-40H-7FH (-64...0...+63)	×	×	×	×	×
01H	31H	mmH	---	EQ TREBLE	mm: 00H-40H-7FH (-64...0...+63)	×	×	×	×	×
01H	34H	mmH	---	EQ BASS Frequency	mm: 04H-28H (32...2.0k [Hz])	×	×	×	×	×
01H	35H	mmH	---	EQ TREBLE Frequency	mm: 1CH-3AH (500...16.0k [Hz])	×	×	×	×	×
01H	63H	mmH	---	EG Attack Time	mm: 00H-40H-7FH (-64...0...+63)	○	×	×	×	×
01H	64H	mmH	---	EG Decay Time	mm: 00H-40H-7FH (-64...0...+63)	○	×	×	×	×
01H	66H	mmH	---	EG Release	mm: 00H-40H-7FH (-64...0...+63)	○	×	×	×	×
14H	rrH	mmH	---	Drum Low Pass Filter Cutoff Frequency	rr: drum instrument note number mm: 00H-40H-7FH (-64...0...+63)	○	×	×	×	×
15H	rrH	mmH	---	Drum Low Pass Filter Resonance	rr: drum instrument note number mm: 00H-40H-7FH (-64...0...+63)	○	×	×	×	×
16H	rrH	mmH	---	Drum EG Attack Rate	rr: drum instrument note number mm: 00H-40H-7FH (-64...0...+63)	○	×	×	×	×
17H	rrH	mmH	---	Drum EG Decay Rate	rr: drum instrument note number mm: 00H-40H-7FH (-64...0...+63)	○	×	×	×	×
18H	rrH	mmH	---	Drum Pitch Coarse	rr: drum instrument note number mm: 00H-40H-7FH (-64...0...+63)	○	×	×	×	×
19H	rrH	mmH	---	Drum Pitch Fine	rr: drum instrument note number mm: 00H-40H-7FH (-64...0...+63)	○	×	×	×	×
1AH	rrH	mmH	---	Drum Level	rr: drum instrument note number mm: 00H-7FH (0...127)	○	×	×	×	×
1CH	rrH	mmH	---	Drum Pan	rr: drum instrument note number mm: 00H, 01H-40H-7FH (RND, L63...C...R63)	○	×	×	×	×
1DH	rrH	mmH	---	Drum Reverb Send Level	rr: drum instrument note number mm: 00H-7FH (0...127)	○	×	×	×	×
1EH	rrH	mmH	---	Drum Chorus Send Level	rr: drum instrument note number mm: 00H-7FH (0...127)	○	×	×	×	×
1FH	rrH	mmH	---	Drum Variation Send Level	rr: drum instrument note number mm: 00H-7FH (0...127) (Variation Connection = SYSTEM) mm: 00H, 01H-7FH (OFF, ON) (Variation Connection = INSERTION)	○	×	×	×	×
24H	rrH	mmH	---	Drum HPF Cutoff Frequency	rr: drum instrument note number mm: 00H-40H-7FH (-64...0...+63)	×	×	×	×	×
30H	rrH	mmH	---	Drum EQ Bass Gain	rr: drum instrument note number mm: 00H-7FH (0...127)	×	×	×	×	×
31H	rrH	mmH	---	Drum EQ Treble Gain	rr: drum instrument note number mm: 00H-7FH (0...127)	×	×	×	×	×
34H	rrH	mmH	---	Drum EQ Bass Frequency	rr: drum instrument note number mm: 04H-28H (32...2.0k [Hz])	×	×	×	×	×
35H	rrH	mmH	---	Drum EQ Treble Frequency	rr: drum instrument note number mm: 1CH-3AH (500...16.0k [Hz])	×	×	×	×	×
40H	rrH	mmH	---	Drum VELOCITY PITCH SENS.	rr: drum instrument note number mm: 00H-0FH (0...15)	×	×	×	×	×
41H	rrH	mmH	---	Drum VELOCITY LPF CUTOFF SENS.	rr: drum instrument note number mm: 00H-0FH (0...15)	×	×	×	×	×

* NRPN MSB: 14H-1FH (for drums) message is accepted as long as the channel is set with a drum voice.
* Data Entry LSB will be ignored.

Parameters Controlled by RPN (Registered Parameter Numbers)

RPN		Data Entry		Parameter	Data Range	[MIDI (Silent)]				
MSB	LSB	MSB	LSB			MIDI Reception	MIDI Transmission			
						Song Part	Piano Playback Channel	Panel Operation	Song Playback	MIDI Input
00H	00H	mmH	---	Pitch Bend Sensitivity [GM1] [GM2]	mm: 00H-18H (0...+24 [semitones])	○	×	×	×	×
00H	01H	mmH	11H	Fine Tune [GM1] [GM2]	mm ll: 00H 00H -100 [cent] ... mm ll: 40H 00H 0 [cent] ... mm ll: 7FH 7FH 100 [cent]	○	×	×	×	×
00H	02H	mmH	---	Coarse Tune [GM1] [GM2]	mm: 28H-40H-58H (-24...0...+24 [semitones])	○	×	×	×	×
00H	05H	mmH	11H	Modulation Sensitivity [GM2]	mm: Specified in semitone increments ll: Specified in 100/128 cent increments	○	×	×	×	×
7FH	7FH	---	---	Null [GM2]	---	○	×	×	×	×

MIDI Parameter Change Table

■ MIDI Parameter Change Table (XG SYSTEM)

Address (H)			Size (H)	Data (H)	Parameter	Description	XG Default (H)	[MIDI (Silent)]				
								MIDI Reception		MIDI Transmission		
								Song Part	Piano Playback Channel	Panel Operation	Song Playback	MIDI Input
00	00	00	4	00-0F 00-0F 00-0F 00-0F	MASTER TUNE	-102.4...0...+102.3 [cent] 1st bit3-0→bit15-12 2nd bit3-0→bit11-8 3rd bit3-0→bit7-4 4th bit3-0→bit3-0	Panel setting value	×	×	×	×	×
		04	1	00-7F	MASTER VOLUME	0...127	7F	○	×	×	×	×
		05	1	00-7F	MASTER ATTENUATOR	0...127	00	×	×	×	×	×
		06	1	28-58	TRANSPOSE	-24...0...+24 [semitones]	40	○	×	×	×	×
		7D	1	N	DRUM SETUP RESET	N: Drum setup number	---	○	×	×	×	×
		7E	1	00	XG SYSTEM ON	00=XG system ON	---	○	×	×	×	×
		7F	1	00	ALL PARAMETER RESET	00=ON	---	○	×	×	×	×
TOTAL SIZE			07									

■ MIDI Parameter Change Table (SYSTEM INFORMATION)

Address (H)			Size (H)	Data (H)	Parameter	Description	[MIDI (Silent)]					
							MIDI Reception		MIDI Transmission			
							Song Part	Piano Playback Channel	Panel Operation	Song Playback	MIDI Input	
01	00	00	E	20-7F ... 0D	Model Name 1 ... Model Name 14	32...127 (ASCII CHARACTER) ... 32...127 (ASCII CHARACTER)		---	---	×	×	○
		0E	1		NOT USED			---	---	---	---	---
		0F	1		NOT USED			---	---	---	---	---
TOTAL SIZE			10									

* Transmitted in response to dump request. Not received.

■ MIDI Parameter Change Table (EFFECT1)

Address (H)			Size (H)	Data (H)	Parameter	Description	XG Default (H)	[MIDI (Silent)]				
								MIDI Reception		MIDI Transmission		
								Song Part	Piano Playback Channel	Panel Operation	Song Playback	MIDI Input
02	01	00	2	00-7F 00-7F	REVERB TYPE MSB REVERB TYPE LSB	Refer to Effect Parameter List	01(=HALL1) 00	○	×	×	×	×
		02	1	00-7F	REVERB PARAMETER 1	Refer to Effect Parameter List	Depends on Reverb Type	○	×	×	×	×
		03	1	00-7F	REVERB PARAMETER 2	Refer to Effect Parameter List	Depends on Reverb Type	○	×	×	×	×
		04	1	00-7F	REVERB PARAMETER 3	Refer to Effect Parameter List	Depends on Reverb Type	○	×	×	×	×
		05	1	00-7F	REVERB PARAMETER 4	Refer to Effect Parameter List	Depends on Reverb Type	○	×	×	×	×
		06	1	00-7F	REVERB PARAMETER 5	Refer to Effect Parameter List	Depends on Reverb Type	○	×	×	×	×
		07	1	00-7F	REVERB PARAMETER 6	Refer to Effect Parameter List	Depends on Reverb Type	○	×	×	×	×
		08	1	00-7F	REVERB PARAMETER 7	Refer to Effect Parameter List	Depends on Reverb Type	○	×	×	×	×
		09	1	00-7F	REVERB PARAMETER 8	Refer to Effect Parameter List	Depends on Reverb Type	○	×	×	×	×
		0A	1	00-7F	REVERB PARAMETER 9	Refer to Effect Parameter List	Depends on Reverb Type	○	×	×	×	×
		0B	1	00-7F	REVERB PARAMETER 10	Refer to Effect Parameter List	Depends on Reverb Type	○	×	×	×	×
		0C	1	00-7F	REVERB RETURN	→dB...0dB...+6dB (0...64...127)	40	○	×	×	×	×
		0D	1	01-7F	REVERB PAN	L63...C...R63	40	○	×	×	×	×
TOTAL SIZE			0E									
02	01	10	1	00-7F	REVERB PARAMETER 11	Refer to Effect Parameter List	Depends on Reverb Type	○	×	×	×	×
		11	1	00-7F	REVERB PARAMETER 12	Refer to Effect Parameter List	Depends on Reverb Type	○	×	×	×	×
		12	1	00-7F	REVERB PARAMETER 13	Refer to Effect Parameter List	Depends on Reverb Type	○	×	×	×	×
		13	1	00-7F	REVERB PARAMETER 14	Refer to Effect Parameter List	Depends on Reverb Type	○	×	×	×	×
		14	1	00-7F	REVERB PARAMETER 15	Refer to Effect Parameter List	Depends on Reverb Type	○	×	×	×	×
		15	1	00-7F	REVERB PARAMETER 16	Refer to Effect Parameter List	Depends on Reverb Type	○	×	×	×	×
TOTAL SIZE			06									

Address (H)		Size (H)	Data (H)	Parameter	Description	XG Default (H)	[MIDI (Silent)]				
							MIDI Reception		MIDI Transmission		
							Song Part	Piano Playback Channel	Panel Operation	Song Playback	MIDI Input
02	01	20	2	00-7F 00-7F	CHORUS TYPE MSB CHORUS TYPE LSB	Refer to Effect Parameter List 41(=CHORUS1)					
		22	1	00-7F	CHORUS PARAMETER 1	Refer to Effect Parameter List Depends on Chorus Type					
		23	1	00-7F	CHORUS PARAMETER 2	Refer to Effect Parameter List Depends on Chorus Type					
		24	1	00-7F	CHORUS PARAMETER 3	Refer to Effect Parameter List Depends on Chorus Type					
		25	1	00-7F	CHORUS PARAMETER 4	Refer to Effect Parameter List Depends on Chorus Type					
		26	1	00-7F	CHORUS PARAMETER 5	Refer to Effect Parameter List Depends on Chorus Type					
		27	1	00-7F	CHORUS PARAMETER 6	Refer to Effect Parameter List Depends on Chorus Type					
		28	1	00-7F	CHORUS PARAMETER 7	Refer to Effect Parameter List Depends on Chorus Type					
		29	1	00-7F	CHORUS PARAMETER 8	Refer to Effect Parameter List Depends on Chorus Type					
		2A	1	00-7F	CHORUS PARAMETER 9	Refer to Effect Parameter List Depends on Chorus Type					
		2B	1	00-7F	CHORUS PARAMETER 10	Refer to Effect Parameter List Depends on Chorus Type					
		2C	1	00-7F	CHORUS RETURN	-->dB...>dB...>dB (0...64...127)	40				
		2D	1	01-7F	CHORUS PAN	L63...C...R63	40				
		2E	1	00-7F	SEND CHORUS TO REVERB	-->dB...>dB...>dB (0...64...127)	00				
TOTAL SIZE		0F									

		30	1	00-7F	CHORUS PARAMETER 11	Refer to Effect Parameter List Depends on Chorus Type					
		31	1	00-7F	CHORUS PARAMETER 12	Refer to Effect Parameter List Depends on Chorus Type					
		32	1	00-7F	CHORUS PARAMETER 13	Refer to Effect Parameter List Depends on Chorus Type					
		33	1	00-7F	CHORUS PARAMETER 14	Refer to Effect Parameter List Depends on Chorus Type					
		34	1	00-7F	CHORUS PARAMETER 15	Refer to Effect Parameter List Depends on Chorus Type					
		35	1	00-7F	CHORUS PARAMETER 16	Refer to Effect Parameter List Depends on Chorus Type					
TOTAL SIZE		06									

Address (H)		Size (H)	Data (H)	Parameter	Description	XG Default (H)	[MIDI (Silent)]				
							MIDI Reception		MIDI Transmission		
							Song Part	Piano Playback Channel	Panel Operation	Song Playback	MIDI Input
02	01	40	2	00-7F 00-7F	VARIATION TYPE MSB VARIATION TYPE LSB	Refer to Effect Parameter List 05 (=DELAY L, C, R)					
		42	2	00-7F 00-7F	VARIATION PARAMETER 1 MSB VARIATION PARAMETER 1 LSB	Refer to Effect Parameter List Depends on Variation Type					
		44	2	00-7F 00-7F	VARIATION PARAMETER 2 MSB VARIATION PARAMETER 2 LSB	Refer to Effect Parameter List Depends on Variation Type					
		46	2	00-7F 00-7F	VARIATION PARAMETER 3 MSB VARIATION PARAMETER 3 LSB	Refer to Effect Parameter List Depends on Variation Type					
		48	2	00-7F 00-7F	VARIATION PARAMETER 4 MSB VARIATION PARAMETER 4 LSB	Refer to Effect Parameter List Depends on Variation Type					
		4A	2	00-7F 00-7F	VARIATION PARAMETER 5 MSB VARIATION PARAMETER 5 LSB	Refer to Effect Parameter List Depends on Variation Type					
		4C	2	00-7F 00-7F	VARIATION PARAMETER 6 MSB VARIATION PARAMETER 6 LSB	Refer to Effect Parameter List Depends on Variation Type					
		4E	2	00-7F 00-7F	VARIATION PARAMETER 7 MSB VARIATION PARAMETER 7 LSB	Refer to Effect Parameter List Depends on Variation Type					
		50	2	00-7F 00-7F	VARIATION PARAMETER 8 MSB VARIATION PARAMETER 8 LSB	Refer to Effect Parameter List Depends on Variation Type					
		52	2	00-7F 00-7F	VARIATION PARAMETER 9 MSB VARIATION PARAMETER 9 LSB	Refer to Effect Parameter List Depends on Variation Type					
		54	2	00-7F 00-7F	VARIATION PARAMETER 10 MSB VARIATION PARAMETER 10 LSB	Refer to Effect Parameter List Depends on Variation Type					
		56	1	00-7F	VARIATION RETURN	-->dB...>dB...>dB (0...64...127)	40				
		57	1	01-7F	VARIATION PAN	L63...C...R63	40				
		58	1	00-7F	SEND VARIATION TO REVERB	-->dB...>dB...>dB (0...64...127)	00				
		59	1	00-7F	SEND VARIATION TO CHORUS	-->dB...>dB...>dB (0...64...127)	00				
		5A	1	00-01	VARIATION CONNECTION	INSERTION, SYSTEM	00				
		5B	1	00-7F	VARIATION PART NUMBER	Reception: Part1...16 (0...15) Transmission: Part1...16 (0...15) AD (64) OFF (127)	7F				
		5C	1	00-7F	MW VARIATION CONTROL DEPTH	-64...0...+63	40				
		5D	1	00-7F	BEND VARIATION CONTROL DEPTH	-64...0...+63	40				
		5E	1	00-7F	CAT VARIATION CONTROL DEPTH	-64...0...+63	40				
		5F	1	00-7F	AC1 VARIATION CONTROL DEPTH	-64...0...+63	40				
		60	1	00-7F	AC2 VARIATION CONTROL DEPTH	-64...0...+63	40				
TOTAL SIZE		21									

		70	1	00-7F	VARIATION PARAMETER 11	Refer to Effect Parameter List Depends on Variation Type					
		71	1	00-7F	VARIATION PARAMETER 12	Refer to Effect Parameter List Depends on Variation Type					
		72	1	00-7F	VARIATION PARAMETER 13	Refer to Effect Parameter List Depends on Variation Type					
		73	1	00-7F	VARIATION PARAMETER 14	Refer to Effect Parameter List Depends on Variation Type					
		74	1	00-7F	VARIATION PARAMETER 15	Refer to Effect Parameter List Depends on Variation Type					
		75	1	00-7F	VARIATION PARAMETER 16	Refer to Effect Parameter List Depends on Variation Type					
TOTAL SIZE		06									

MIDI Parameter Change Table (MULTI EQ)

Address (H)		Size (H)	Data (H)	Parameter	Description	
02	40	00	1	00-04	EQ TYPE	flat, jazz, pops, rock, classic
		01	1	34-4C	EQ GAIN1	-12...0...+12 [dB]
		02	1	04-28	EQ FREQUENCY1	32...2.0k [Hz]
		03	1	01-78	EQ Q1	0.1...12.0
		04	1	00-01	EQ SHAPE1	shelving, peaking
		05	1	34-4C	EQ GAIN2	-12...0...+12 [dB]
		06	1	0E-36	EQ FREQUENCY2	100...10.0k [Hz]
		07	1	01-78	EQ Q2	0.1...12.0
		08	1		NOT USED	
		09	1	34-4C	EQ GAIN3	-12...0...+12 [dB]
		0A	1	0E-36	EQ FREQUENCY3	100...10.0k [Hz]
		0B	1	01-78	EQ Q3	0.1...12.0
		0C	1		NOT USED	
		0D	1	34-4C	EQ GAIN4	-12...0...+12 [dB]
		0E	1	0E-36	EQ FREQUENCY4	100...10.0k [Hz]
		0F	1	01-78	EQ Q4	0.1...12.0
		10	1		NOT USED	
		11	1	34-4C	EQ GAIN5	-12...0...+12 [dB]
		12	1	1C-3A	EQ FREQUENCY5	0.5k...16.0k [Hz]
		13	1	01-78	EQ Q5	0.1...12.0
		14	1	00-01	EQ SHAPE5	shelving, peaking

TOTAL SIZE 15

* The MULTI EQ parameter cannot be reset to its factory setting with XG SYSTEM on.

[MIDI (Silent)]

MIDI Reception		MIDI Transmission		
Song Part	Piano Playback Channel	Panel Operation	Song Playback	MIDI Input
x	x	x	x	x
x	x	x	x	x
x	x	x	x	x
x	x	x	x	x
x	x	x	x	x
x	x	x	x	x
x	x	x	x	x
x	x	x	x	x
x	x	x	x	x
x	x	x	x	x
x	x	x	x	x
x	x	x	x	x
x	x	x	x	x
x	x	x	x	x
x	x	x	x	x

MIDI Parameter Change Table (EFFECT2)

Address (H)		Size (H)	Data (H)	Parameter	Description	
03	n	00	2	00-7F 00-7F	INSERTION EFFECT TYPE MSB INSERTION EFFECT TYPE LSB	Refer to Effect Parameter List
		02	1	00-7F	INSERTION EFFECT PARAMETER 1	Refer to Effect Parameter List
		03	1	00-7F	INSERTION EFFECT PARAMETER 2	Refer to Effect Parameter List
		04	1	00-7F	INSERTION EFFECT PARAMETER 3	Refer to Effect Parameter List
		05	1	00-7F	INSERTION EFFECT PARAMETER 4	Refer to Effect Parameter List
		06	1	00-7F	INSERTION EFFECT PARAMETER 5	Refer to Effect Parameter List
		07	1	00-7F	INSERTION EFFECT PARAMETER 6	Refer to Effect Parameter List
		08	1	00-7F	INSERTION EFFECT PARAMETER 7	Refer to Effect Parameter List
		09	1	00-7F	INSERTION EFFECT PARAMETER 8	Refer to Effect Parameter List
		0A	1	00-7F	INSERTION EFFECT PARAMETER 9	Refer to Effect Parameter List
		0B	1	00-7F	INSERTION EFFECT PARAMETER 10	Refer to Effect Parameter List
		0C	1	00-7F	INSERTION EFFECT PART NUMBER	Reception: Part1...16 (0...15) Transmission: Part1...16 (0...15) AD (64) OFF (127)
		0D	1	00-7F	MW INSERTION CONTROL DEPTH	-64...0...+63
		0E	1	00-7F	BEND INSERTION CONTROL DEPTH	-64...0...+63
		0F	1	00-7F	CAT INSERTION CONTROL DEPTH	-64...0...+63
		10	1	00-7F	AC1 INSERTION CONTROL DEPTH	-64...0...+63
		11	1	00-7F	AC2 INSERTION CONTROL DEPTH	-64...0...+63

TOTAL SIZE 12

		20	1	00-7F	INSERTION EFFECT PARAMETER 11	Refer to Effect Parameter List
		21	1	00-7F	INSERTION EFFECT PARAMETER 12	Refer to Effect Parameter List
		22	1	00-7F	INSERTION EFFECT PARAMETER 13	Refer to Effect Parameter List
		23	1	00-7F	INSERTION EFFECT PARAMETER 14	Refer to Effect Parameter List
		24	1	00-7F	INSERTION EFFECT PARAMETER 15	Refer to Effect Parameter List
		25	1	00-7F	INSERTION EFFECT PARAMETER 16	Refer to Effect Parameter List

TOTAL SIZE 6

		30	2	00-7F 00-7F	INSERTION EFFECT PARAMETER 1 MSB INSERTION EFFECT PARAMETER 1 LSB	Refer to Effect Parameter List
		32	2	00-7F 00-7F	INSERTION EFFECT PARAMETER 2 MSB INSERTION EFFECT PARAMETER 2 LSB	Refer to Effect Parameter List
		34	2	00-7F 00-7F	INSERTION EFFECT PARAMETER 3 MSB INSERTION EFFECT PARAMETER 3 LSB	Refer to Effect Parameter List
		36	2	00-7F 00-7F	INSERTION EFFECT PARAMETER 4 MSB INSERTION EFFECT PARAMETER 4 LSB	Refer to Effect Parameter List
		38	2	00-7F 00-7F	INSERTION EFFECT PARAMETER 5 MSB INSERTION EFFECT PARAMETER 5 LSB	Refer to Effect Parameter List
		3A	2	00-7F 00-7F	INSERTION EFFECT PARAMETER 6 MSB INSERTION EFFECT PARAMETER 6 LSB	Refer to Effect Parameter List
		3C	2	00-7F 00-7F	INSERTION EFFECT PARAMETER 7 MSB INSERTION EFFECT PARAMETER 7 LSB	Refer to Effect Parameter List
		3E	2	00-7F 00-7F	INSERTION EFFECT PARAMETER 8 MSB INSERTION EFFECT PARAMETER 8 LSB	Refer to Effect Parameter List
		40	2	00-7F 00-7F	INSERTION EFFECT PARAMETER 9 MSB INSERTION EFFECT PARAMETER 9 LSB	Refer to Effect Parameter List
		42	2	00-7F 00-7F	INSERTION EFFECT PARAMETER 10 MSB INSERTION EFFECT PARAMETER 10 LSB	Refer to Effect Parameter List

TOTAL SIZE 14

* The EFFECT2 parameter cannot be reset to its factory setting with XG SYSTEM on.

The second byte of the address is considered as an insertion effect number.
n: insertion effect number

The insertion effect number range is from 0 to 1. Values outside the range are handled as unknown and ignored.

For effect types that do not require MSB, the parameters for address 02-0B will be received and the parameters for address 30-42 will not be received.

For effect types that require MSB, the parameters for address 30-42 will be received and the parameters for address 02-0B will not be received.

When bulk dumps that include effect type data are transmitted, the parameters for address 02-0B will always be transmitted. However, for effect types that require MSB, the parameters for address 02-0B will not be received when the bulk dump is received.

[MIDI (Silent)]

MIDI Reception		MIDI Transmission		
Song Part	Piano Playback Channel	Panel Operation	Song Playback	MIDI Input
x	x	x	x	x
x	x	x	x	x
x	x	x	x	x
x	x	x	x	x
x	x	x	x	x
x	x	x	x	x
x	x	x	x	x
x	x	x	x	x
x	x	x	x	x
x	x	x	x	x
x	x	x	x	x
x	x	x	x	x
x	x	x	x	x
x	x	x	x	x
x	x	x	x	x

x	x	x	x	x
x	x	x	x	x
x	x	x	x	x
x	x	x	x	x
x	x	x	x	x
x	x	x	x	x

x	x	x	x	x
x	x	x	x	x
x	x	x	x	x
x	x	x	x	x
x	x	x	x	x
x	x	x	x	x
x	x	x	x	x
x	x	x	x	x
x	x	x	x	x
x	x	x	x	x
x	x	x	x	x
x	x	x	x	x
x	x	x	x	x
x	x	x	x	x

MIDI Parameter Change Table (MULTI PART)

Address (H)	Size (H)	Data (H)	Parameter	Description	XG Default (H)	[MIDI (Silent)]						
						MIDI Reception Song Part	MIDI Reception Piano Playback Channel	MIDI Transmission Panel Operation	MIDI Transmission Song Playback	MIDI Transmission MIDI Input		
08	nn	00	1	00-20	NOT USED		x	x	x	x	x	
		01	1	00-7F	BANK SELECT MSB	0...127	part10=7F, other parts=00	○	○	x	x	x
		02	1	00-7F	BANK SELECT LSB	0...127	00	○	○	x	x	x
		03	1	00-7F	PROGRAM NUMBER	1...128	00	○	○	x	x	x
		04	1	00-0E, 7F	Rcv CHANNEL	1...16, OFF	Part No.	○	x	x	x	x
		05	1	00-01	MONO/POLY MODE	MONO, POLY	01	○	x	x	x	x
		06	1	00-02	SAME NOTE NUMBER KEY ON ASSIGN	SINGLE, MULTI, INST (for Drum)	01	○	x	x	x	x
		07	1	00-03	PART MODE	NORMAL, DRUM, DRUMS1...2	part10=02, other parts=00	○	x	x	x	x
		08	1	28-58	NOTE SHIFT	-24...0...+24 [semitones]	40	○	x	x	x	x
		09	2	00-0F, 00-0F	DETUNE	-12.8...0...+12.7 [Hz] 1st bit3-0→bit7-4 2nd bit3-0→bit3-0	08 00	○	x	x	x	x
		0B	1	00-7F	VOLUME	0...127	64	○	x	x	x	x
		0C	1	00-7F	VELOCITY SENSE DEPTH	0...127	40	○	x	x	x	x
		0D	1	00-7F	VELOCITY SENSE OFFSET	0...127	40	○	x	x	x	x
		0E	1	00-7F	PAN	RND, L63...C...R63	40	○	x	x	x	x
		0F	1	00-7F	NOTE LIMIT LOW	C-2...G8	00	○	x	x	x	x
		10	1	00-7F	NOTE LIMIT HIGH	C-2...G8	7F	○	x	x	x	x
		11	1	00-7F	DRY LEVEL	0...127	7F	○	x	x	x	x
		12	1	00-7F	CHORUS SEND	0...127	00	○	x	x	x	x
		13	1	00-7F	REVERB SEND	0...127	28	○	x	x	x	x
		14	1	00-7F	VARIATION SEND	0...127	00	○	x	x	x	x
		15	1	00-7F	VIBRATO RATE	-64...0...+63	40	○	x	x	x	x
		16	1	00-7F	VIBRATO DEPTH	-64...0...+63	40	○	x	x	x	x
		17	1	00-7F	VIBRATO DELAY	-64...0...+63	40	○	x	x	x	x
		18	1	00-7F	FILTER CUTOFF FREQUENCY	-64...0...+63	40	○	x	x	x	x
		19	1	00-7F	FILTER RESONANCE	-64...0...+63	40	○	x	x	x	x
		1A	1	00-7F	EG ATTACK TIME	-64...0...+63	40	○	x	x	x	x
		1B	1	00-7F	EG DECAY TIME	-64...0...+63	40	○	x	x	x	x
		1C	1	00-7F	EG RELEASE TIME	-64...0...+63	40	○	x	x	x	x
		1D	1	28-58	H	-24...0...+24 [semitones]	40	○	x	x	x	x
		1E	1	00-7F	MW LOW PASS FILTER CONTROL	-9600...0...+9450 [cent]	40	○	x	x	x	x
		1F	1	00-7F	MW AMPLITUDE CONTROL	-100...0...+100 [%]	40	○	x	x	x	x
		20	1	00-7F	MW LFO PMOD DEPTH	0...127	0A	○	x	x	x	x
		21	1	00-7F	MW LFO FMOD DEPTH	0...127	00	○	x	x	x	x
		22	1	00-7F	MW LFO AMOD DEPTH	0...127	00	○	x	x	x	x
		23	1	28-58	BEND PITCH CONTROL	-24...0...+24 [semitones]	42	○	x	x	x	x
		24	1	00-7F	BEND LOW PASS FILTER CONTROL	-9600...0...+9450 [cent]	40	○	x	x	x	x
		25	1	00-7F	BEND AMPLITUDE CONTROL	-100...0...+100 [%]	40	○	x	x	x	x
		26	1	00-7F	BEND LFO PMOD DEPTH	0...127	00	○	x	x	x	x
		27	1	00-7F	BEND LFO FMOD DEPTH	0...127	00	○	x	x	x	x
		28	1	00-7F	BEND LFO AMOD DEPTH	0...127	00	○	x	x	x	x
TOTAL SIZE						29						
		30	1	00-01	Rcv PITCH BEND	OFF, ON	01	○	x	x	x	x
		31	1	00-01	Rcv CH AFTER TOUCH (CAT)	OFF, ON	01	○	x	x	x	x
		32	1	00-01	Rcv PROGRAM CHANGE	OFF, ON	01	○	x	x	x	x
		33	1	00-01	Rcv CONTROL CHANGE	OFF, ON	01	○	x	x	x	x
		34	1	00-01	Rcv POLY AFTER TOUCH (PAT)	OFF, ON	01	○	x	x	x	x
		35	1	00-01	Rcv NOTE MESSAGE	OFF, ON	01	○	x	x	x	x
		36	1	00-01	Rcv RPN	OFF, ON	01	○	x	x	x	x
		37	1	00-01	Rcv NRPN	OFF, ON	XGmode=01, GMmode=00	○	x	x	x	x
		38	1	00-01	Rcv MODULATION	OFF, ON	01	○	x	x	x	x
		39	1	00-01	Rcv VOLUME	OFF, ON	01	○	x	x	x	x
		3A	1	00-01	Rcv PAN	OFF, ON	01	○	x	x	x	x
		3B	1	00-01	Rcv EXPRESSION	OFF, ON	01	○	x	x	x	x
		3C	1	00-01	Rcv HOLD1	OFF, ON	01	○	x	x	x	x
		3D	1	00-01	Rcv PORTAMENTO	OFF, ON	01	○	x	x	x	x
		3E	1	00-01	Rcv SOSTENUTO	OFF, ON	01	○	x	x	x	x
		3F	1	00-01	Rcv SOFT PEDAL	OFF, ON	01	○	x	x	x	x
		40	1	00-01	Rcv BANK SELECT	OFF, ON	01	○	x	x	x	x
		41	1	00-7F	SCALE TUNING C	-63...0...+63 [cent]	40	○	x	x	x	x
		42	1	00-7F	SCALE TUNING C#	-63...0...+63 [cent]	40	○	x	x	x	x
		43	1	00-7F	SCALE TUNING D	-63...0...+63 [cent]	40	○	x	x	x	x
		44	1	00-7F	SCALE TUNING D#	-63...0...+63 [cent]	40	○	x	x	x	x
		45	1	00-7F	SCALE TUNING E	-63...0...+63 [cent]	40	○	x	x	x	x
		46	1	00-7F	SCALE TUNING F	-63...0...+63 [cent]	40	○	x	x	x	x
		47	1	00-7F	SCALE TUNING F#	-63...0...+63 [cent]	40	○	x	x	x	x
		48	1	00-7F	SCALE TUNING G	-63...0...+63 [cent]	40	○	x	x	x	x
		49	1	00-7F	SCALE TUNING G#	-63...0...+63 [cent]	40	○	x	x	x	x
		4A	1	00-7F	SCALE TUNING A	-63...0...+63 [cent]	40	○	x	x	x	x
		4B	1	00-7F	SCALE TUNING A#	-63...0...+63 [cent]	40	○	x	x	x	x
		4C	1	00-7F	SCALE TUNING B	-63...0...+63 [cent]	40	○	x	x	x	x
		4D	1	28-58	CAT PITCH CONTROL	-24...0...+24 [semitones]	40	○	x	x	x	x
		4E	1	00-7F	CAT LOW PASS FILTER CONTROL	-9600...0...+9450 [cent]	40	○	x	x	x	x
		4F	1	00-7F	CAT AMPLITUDE CONTROL	-100...0...+100 [%]	40	○	x	x	x	x
		50	1	00-7F	CAT LFO PMOD DEPTH	0...127	00	○	x	x	x	x
		51	1	00-7F	CAT LFO FMOD DEPTH	0...127	00	○	x	x	x	x
		52	1	00-7F	CAT LFO AMOD DEPTH	0...127	00	○	x	x	x	x

MIDI Data Format

[MIDI (Silent)]

Address (H)	Size (H)	Data (H)	Parameter	Description	XG Default (H)	MIDI Reception		MIDI Transmission			
						Song Part	Piano Playback Channel	Panel Operation	Song Playback	MIDI Input	
	53	1	28-58	PAT PITCH CONTROL	-24...0...+24 [semitones]	40	○	x	x	x	x
	54	1	00-7F	PAT LOW PASS FILTER CONTROL	-9600...0...+9450 [cent]	40	○	x	x	x	x
	55	1	00-7F	PAT AMPLITUDE CONTROL	-100...0...+100 [%]	40	○	x	x	x	x
	56	1	00-7F	PAT LFO PMOD DEPTH	0...127	00	○	x	x	x	x
	57	1	00-7F	PAT LFO FMOD DEPTH	0...127	00	○	x	x	x	x
	58	1	00-7F	PAT LFO AMOD DEPTH	0...127	00	○	x	x	x	x
	59	1	00-5F	AC1 CONTROLLER NUMBER	0...95	10	○	x	x	x	x
	5A	1	28-58	AC1 PITCH CONTROL	-24...0...+24 [semitones]	40	○	x	x	x	x
	5B	1	00-7F	AC1 LOW PASS FILTER CONTROL	-9600...0...+9450 [cent]	40	○	x	x	x	x
	5C	1	00-7F	AC1 AMPLITUDE CONTROL	-100...0...+100 [%]	40	○	x	x	x	x
	5D	1	00-7F	AC1 LFO PMOD DEPTH	0...127	00	○	x	x	x	x
	5E	1	00-7F	AC1 LFO FMOD DEPTH	0...127	00	○	x	x	x	x
	5F	1	00-7F	AC1 LFO AMOD DEPTH	0...127	00	○	x	x	x	x
	60	1	00-5F	AC2 CONTROLLER NUMBER	0...95	11	○	x	x	x	x
	61	1	28-58	AC2 PITCH CONTROL	-24...0...+24 [semitones]	40	○	x	x	x	x
	62	1	00-7F	AC2 LOW PASS FILTER CONTROL	-9600...0...+9450 [cent]	40	○	x	x	x	x
	63	1	00-7F	AC2 AMPLITUDE CONTROL	-100...0...+100 [%]	40	○	x	x	x	x
	64	1	00-7F	AC2 LFO PMOD DEPTH	0...127	00	○	x	x	x	x
	65	1	00-7F	AC2 LFO FMOD DEPTH	0...127	00	○	x	x	x	x
	66	1	00-7F	AC2 LFO AMOD DEPTH	0...127	00	○	x	x	x	x
	67	1	00-01	PORTAMENTO SWITCH	OFF, ON	00	○	x	x	x	x
	68	1	00-7F	PORTAMENTO TIME	0...127	00	○	x	x	x	x
	69	1	00-7F	PITCH EG INITIAL LEVEL	-64...0...+63	40	○	x	x	x	x
	6A	1	00-7F	PITCH EG ATTACK TIME	-64...0...+63	40	○	x	x	x	x
	6B	1	00-7F	PITCH EG RELEASE LEVEL	-64...0...+63	40	○	x	x	x	x
	6C	1	00-7F	PITCH EG RELEASE TIME	-64...0...+63	40	○	x	x	x	x
	6D	1	01-7F	VELOCITY LIMIT LOW	1...127	01	○	x	x	x	x
	6E	1	01-7F	VELOCITY LIMIT HIGH	1...127	7F	○	x	x	x	x
TOTAL SIZE		3F									

	70	1		NOT USED		—	—	—	—	—
	71	1		NOT USED		—	—	—	—	—
	72	1	00-7F	EQ BASS GAIN	-12dB...+12dB	40	x	x	x	x
	73	1	00-7F	EQ TREBLE GAIN	-12dB...+12dB	40	x	x	x	x
TOTAL SIZE		04								

	74	1		NOT USED		—	—	—	—	—
	75	1		NOT USED		—	—	—	—	—
	76	1	04-28	EQ BASS FREQUENCY	32...2.0k [Hz]	0C	x	x	x	x
	77	1	1C-3A	EQ TREBLE FREQUENCY	500...16.0k [Hz]	36	x	x	x	x
	78	1		NOT USED		—	—	—	—	—
	79	1		NOT USED		—	—	—	—	—
	7A	1		NOT USED		—	—	—	—	—
	7B	1		NOT USED		—	—	—	—	—
	7C	1		NOT USED		—	—	—	—	—
	7D	1		NOT USED		—	—	—	—	—
	7E	1		NOT USED		—	—	—	—	—
	7F	1		NOT USED		—	—	—	—	—
TOTAL SIZE		0C								

0A	nn	40	1	00-7F	MW OFFSET LEVEL CONTROL	-100 - 100 [%]	○	x	x	x	x
		41	1	00-7F	BEND OFFSET LEVEL CONTROL	-100 - 100 [%]	○	x	x	x	x
		42	1	00-7F	CAT OFFSET LEVEL CONTROL	-100 - 100 [%]	○	x	x	x	x
		43	1	00-7F	PAT OFFSET LEVEL CONTROL	-100 - 100 [%]	○	x	x	x	x
		44	1	00-7F	AC1 OFFSET LEVEL CONTROL	-100 - 100 [%]	○	x	x	x	x
		45	1	00-7F	AC2 OFFSET LEVEL CONTROL	-100 - 100 [%]	○	x	x	x	x
TOTAL SIZE		06									

nn: part number

If there is a Drum voice assigned to the part, the following parameters are ineffective.

- BANK SELECT LSB
- PORTAMENTO
- MONO/POLY
- SCALE TUNING
- POLY AFTER TOUCH
- PITCH EG

MIDI Parameter Change Table (DRUM SETUP)

							[MIDI (Silent)]				
Address (H)		Size (H)	Data (H)	Parameter	Description	XG Default (H)	MIDI Reception		MIDI Transmission		
							Song Part	Piano Playback Channel	Panel Operation	Song Playback	MIDI Input
3n	rr	00	1	00-7F	PITCH COARSE	-64...0...+63					
		01	1	00-7F	PITCH FINE	-64...0...+63 [cent]	40	○	×	×	×
		02	1	00-7F	LEVEL	0...127	Depends on the note	○	×	×	×
		03	1	00-7F	ALTERNATE GROUP	OFF, 1...127	Depends on the note	○	×	×	×
		04	1	00-7F	PAN	RND, L63...C...R63	Depends on the note	○	×	×	×
		05	1	00-7F	REVERB SEND	0...127	Depends on the note	○	×	×	×
		06	1	00-7F	CHORUS SEND	0...127	Depends on the note	○	×	×	×
		07	1	00-7F	VARIATION SEND	0...127	Depends on the note	○	×	×	×
		08	1	00-01	KEY ASSIGN	SINGLE, MULTI	00	○	×	×	×
		09	1	00-01	Rcv NOTE OFF	OFF, ON	Depends on the note	○	×	×	×
		0A	1	00-01	Rcv NOTE ON	OFF, ON	01	○	×	×	×
		0B	1	00-7F	LOW PASS FILTER CUTOFF FREQUENCY	-64...0...+63	40	○	×	×	×
		0C	1	00-7F	LOW PASS FILTER RESONANCE	-64...0...+63	40	○	×	×	×
		0D	1	00-7F	EG ATTACK RATE	-64...0...+63	40	○	×	×	×
		0E	1	00-7F	EG DECAY1 RATE	-64...0...+63	40	○	×	×	×
		0F	1	00-7F	EG DECAY2 RATE	-64...0...+63	40	○	×	×	×
TOTAL SIZE		10									
		20	1	00-7F	EQ BASS GAIN	-12...+12 [dB]	40	×	×	×	×
		21	1	00-7F	EQ TREBLE GAIN	-12...+12 [dB]	40	×	×	×	×
		22	1		NOT USED		---	---	---	---	
		23	1		NOT USED		---	---	---	---	
		24	1	04-28	EQ BASS FREQUENCY	32...2.0k [Hz]	0C	×	×	×	×
		25	1	1C-3A	EQ TREBLE FREQUENCY	500...16.0k [Hz]	36	×	×	×	×
		26	1		NOT USED		---	---	---	---	
		27	1		NOT USED		---	---	---	---	
		28	1		NOT USED		---	---	---	---	
		29	1		NOT USED		---	---	---	---	
		2A	1		NOT USED		---	---	---	---	
		2B	1		NOT USED		---	---	---	---	
		2C	1		NOT USED		---	---	---	---	
		2D	1		NOT USED		---	---	---	---	
TOTAL SIZE		0E									

n: drum setup number (0-1)
 rr: note number (0D-5B)

In the following cases, the unit will initialize all drum setups.

- XG SYSTEM ON received
- GM SYSTEM ON received
- GM LEVEL 2 SYSTEM ON received
- GS RESET received
- DRUM SETUP RESET received (only when in XG mode)

When a part to which a drum setup is assigned receives a program change, the assigned drum setup will be initialized.

If the same drum setup is assigned to two or more parts, changes in drum setup parameters (including program changes) will apply to all parts to which it is assigned.

System Exclusive Messages (1)

- * Not received when Receive System Exclusive Message is set to off.
- * Not transmitted when Transmit System Exclusive Message is set to off.

■ System Exclusive Messages (Universal Non Realtime Messages)

MIDI Event	Data Format	[MIDI (Silent)]				
		MIDI Reception		MIDI Transmission		
		Song Part	Piano Playback Channel	Panel Operation	Song Playback	MIDI Input
GM1 System On [GM1][GM2]	F0 7E XN 09 01 F7 11110000 F0 = Exclusive status 01111110 7E = Universal Non-Real Time 0xxxxnmm XN = When N is received N=0-F, whichever is received. X=ignored 00001001 09 = Sub-ID #1=General MIDI Message 00000001 01 = Sub-ID #2=General MIDI On 11110111 F7 = End of Exclusive	○	×	×	×	×

System Exclusive Messages (2)

■ System Exclusive Messages (XG)

MIDI Event	Data Format	[MIDI (Silent)]			
		MIDI Reception		MIDI Transmission	
		Song Part	Piano Playback Channel	Panel Operation	Song Playback
XG Parameter Change	F0 43 1n 4C hh mm ll dd ... F7 11110000 F0 = Exclusive status 01000011 43 = YAMAHA ID 0001nmm 1n = Device Number n=always 0 (when transmit), n=0-F (when receive) 01001100 4C = Model ID 0hhhhhhh hh = Address High 0mmmmmmm mm = Address Mid 0lllllll ll = Address Low 0ddddd dd = Data ... 11110111 F7 = End of Exclusive	○		×	×
XG Bulk Dump	F0 43 0n 4C aa bb hh mm ll dd ... dd cc F7 11110000 F0 = Exclusive status 01000011 43 = YAMAHA ID 0000nnn 0n = Device Number n=always 0 (when transmit), n=0-F (when receive) 01001100 4C = Model ID 0aaaaaaa aa = Byte Count MSB 0bbbbbbb bb = Byte Count LSB 0hhhhhhh hh = Address High 0mmmmmmm mm = Address Mid 0lllllll ll = Address Low 0ddddd dd = Data : 0ddddd dd = Data 0ccccc cc = Checksum 11110111 F7 = End of Exclusive	○		×	×
XG Parameter Request	F0 43 3n 4C hh ll F7 11110000 F0 = Exclusive status 01000011 43 = YAMAHA ID 0011nmm 3n = Device Number n=always 0 (when transmit), n=0-F (when receive) 01001100 4C = Model ID 0hhhhhhh hh = Address High 0mmmmmmm mm = Address Mid 0lllllll ll = Address Low 11110111 F7 = End of Exclusive	○		×	×
XG Dump Request	F0 43 2n 4C hh mm ll F7 11110000 F0 = Exclusive status 01000011 43 = YAMAHA ID 0010nnn 2n = Device Number n=always 0 (when transmit), n=0-F (when receive) 01001100 4C = Model ID 0hhhhhhh hh = Address High 0mmmmmmm mm = Address Mid 0lllllll ll = Address Low 11110111 F7 = End of Exclusive	○		×	×

■ System Exclusive Messages (Others)

MIDI Event	Data Format	[MIDI (Silent)]			
		MIDI Reception		MIDI Transmission	
		Song Part	Piano Playback Channel	Panel Operation	Song Playback
MIDI Master Tuning	F0 43 1n 27 30 00 00 mm ll cc F7 11110000 F0 = Exclusive status 01000011 43 = YAMAHA ID 0001nnn 1n = always 0 (when transmit), n=0-F (when receive) 00100111 27 = Model ID of TG100 00110000 30 = Address High 00000000 00 = Address Mid 00000000 00 = Address Low 0000mmmm 0m = Master Tune MSB 0000llll 0l = Master Tune LSB 0ccccc cc = don't care 11110111 F7 = End of Exclusive	×	×	×	×

■ System Exclusive Messages (Preset Voice)

MIDI Event	Data Format	[MIDI (Silent)]			
		MIDI Reception		MIDI Transmission	
		Song Part	Piano Playback Channel	Panel Operation	Song Playback
String Resonance Depth	F0 43 73 01 50 11 0n 02 dd F7 11110000 F0 = Exclusive status 01000011 43 = YAMAHA ID 01110011 73 = Clavinova ID 00000001 01 = Model ID (Clavinova common ID) 01010000 50 = SubID 00010001 11 = SubID 0000nnnn 0n = Channel (00-0F) 00000010 02 = SubID (String Resonance Depth) 0ddddd dd = Depth (00-48) 11110111 F7 = End of Exclusive	○	×	×	×
Sustain Sample Depth	F0 43 73 01 50 11 0n 03 dd F7 11110000 F0 = Exclusive status 01000011 43 = YAMAHA ID 01110011 73 = Clavinova ID 00000001 01 = Model ID (Clavinova common ID) 01010000 50 = SubID 00010001 11 = SubID 0000nnnn 0n = Channel (00-0F) 00000011 03 = SubID (Sustain Sample Depth) 0ddddd dd = Depth (00-48) 11110111 F7 = End of Exclusive	○	×	×	×
Key Off Sampling Depth	F0 43 73 01 50 11 0n 04 dd F7 11110000 F0 = Exclusive status 01000011 43 = YAMAHA ID 01110011 73 = Clavinova ID 00000001 01 = Model ID (Clavinova common ID) 01010000 50 = SubID 00010001 11 = SubID 0000nnnn 0n = Channel (00-0F) 00000100 04 = SubID (Key Off Sampling Depth) 0ddddd dd = Depth (00-50) 11110111 F7 = End of Exclusive	○	×	×	×
Soft Pedal Depth	F0 43 73 01 50 11 0n 05 dd F7 11110000 F0 = Exclusive status 01000011 43 = YAMAHA ID 01110011 73 = Clavinova ID 00000001 01 = Model ID (Clavinova common ID) 01010000 50 = SubID 00010001 11 = SubID 0000nnnn 0n = Channel (00-0F) 00000101 05 = SubID (Soft Pedal Depth) 0ddddd dd = Depth (00-7F) 11110111 F7 = End of Exclusive	○	×	×	×

* For each depth value, the rest value is 40H = voice parameter.

MIDI IMPLEMENTATION CHART

Yamaha Disklavier
Model: ENSPIRE ST/PRO

Date: 01-APR-2016
Version: 1.00

Function...		Transmitted	Recognized	Remarks
Basic Channel	Default	1-16	1-16	Memorized
	Changed	1-16	1-16	
Mode	Default	3	3	
	Messages	x	3, 4 (m=1) *1, *2	
	Altered	*****	x	
Note Number		o 21-108	0-127	
	: True Note	*****	0-127	
Velocity	Note ON	o 9nH, v=1-127	o v=1-127	
	Note OFF	o 8nH, v=0-127	o	
After Touch	Key's	o *4	x	
	Ch's	x	x	
Pitch Bend		x	o 0-24 semi *1	
Control Change	0, 32	x	o *1	Bank Select
	7, 11	x	o	
	1, 5, 10	x	o *1	
	6, 38	x	o *1	Data Entry
	64	o	o	Hold1 (Sustain)
	65	x	o *1	Portament
	66	o *3	o *1	Sostenuto
	67	o	o	Soft (Shift) Pedal
	71-74, 84	x	o *1	
	91, 93, 94	x	o *1	Effect Depth
96-101	x	o *1		
Prog Change		x	o 0-127	
	: True #	*****		
System Exclusive		o	o	
Common	: Song Pos	x	x	
	: Song Sel	x	x	
	: Tune	x	x	
System Real Time	: Clock	x	x	
	: Commands	x	x	
Aux Messages	: All Sound OFF	o	o (120, 126, 127)	
	: Reset All Cntrls	x	o (121)	
	: Local ON/OFF	x	o	
	: All Notes OFF	o	o (123-125)	
	: Active Sense	o	o	
	: Reset	x	x	
Notes	*1 = Only ESBL Part can recognized. *2 = m is always treated as 1 regardless of value. *3 = Transmit if this model has a Sostenuto Pedal. *4 = Applying further pressure on the key does not output key aftertouch information.			

Mode 1 : OMNI ON. POLY Mode 2 : OMNI ON. MONO o : YES
 Mode 3 : OMNI OFF. POLY Mode 4 : OMNI OFF. MONO x : NO

