

**SAMSON**

**AirLine**  
MICRO   
WIRELESS EARSET SYSTEM



**OWNERS MANUAL**

## Table of Contents

Introduction . . . . .	1
System Components . . . . .	3
Quick Start . . . . .	4
Wearing the AH2 Transmitter . . . . .	7
Guided Tour - AR2 Receiver . . . . .	8
Guided Tour - AH2 Transmitter . . . . .	10
AR2 Dock . . . . .	12
Specifications . . . . .	13
AirLine Micro Channel Plan . . . . .	14

**Samson Technologies Corp.**

v2.1

45 Gilpin Avenue

Hauppauge, New York 11788-8816

Phone: 1-800-3-SAMSON

Fax: 631-784-2201

[www.samsontech.com](http://www.samsontech.com)

## Introduction

Thank you for purchasing the Samson AirLine Micro Earset wireless system, a breakthrough in wireless microphone technology. Wireless systems were originally developed to eliminate cables. Samson took this one step further by creating the AH2 single earset transmitter, which provides unparalleled freedom of movement. The AirLine Micro features an integrated omnidirectional microphone and flexible gooseneck boom, which always allows you to obtain the perfect position to pick up your voice, even during high-impact performance. The frequency response of the transmitter has been tailored for accurate and articulate vocal reproduction. The AH2 transmitter is also water resistant, and designed with extra care to ensure that no moisture can accumulate during performances. This makes the AH2 perfectly suited for aerobics instructors, and high-energy performers and presenters.

Housed in a rugged aluminum chassis with retractable antennas, the AR2 provides the ultimate in portability and flexibility. The AR2 micro receiver features an 1/8" unbalanced audio output, with microphone or line level output, USB DC-input, and RF and Battery LED indicators. The included AR2D dock provides stability for the receiver, and facilitates ease of use.

The AirLine Micro utilizes the latest in miniaturized electronic components, as well as lithium ion batteries, which result in Samson's smallest and most comfortable wireless system, while preserving the high-quality audio you expect out of a Samson wireless device. The AirLine Micro system ensures clear, interruption-free performance by incorporating tone-key with auto-mute, which only allows the transmitter's audio to pass through the receiver, and mutes the output if there is interference.

The AirLine Micro system uses fully rechargeable Lithium Ion technology. The AirLine Micro AH2 transmitter and AR2 receiver feature internal rechargeable batteries for 10 hours of battery operation. Both the AH2 and AR2 can be recharged with the included AC adaptor and USB Y-cable. The AR2 can be powered directly off of the AC adaptor, for continuous operation. The AH2 and AR2 can also be recharged by USB bus power when connected to any USB host-equipped device.

## Introduction

In this manual, you'll find a detailed description of the features of your AirLine Micro Earset system, as well as a guided tour of its components, step-by-step instructions for setting up and using your system, and full specifications. If your AirLine Micro Earset system was purchased in the United States, you'll also find a warranty card enclosed—don't forget to fill it out and mail it! This will enable you to receive online technical support and will allow us to send you updated information about this and other Samson products in the future. If your Airline Micro Earset system was purchased outside of the U.S., contact your local distributor for warranty details. Also, be sure to check out our website (<http://www.samsontech.com>) for information about our full product line.

**SPECIAL NOTE for U.S. Purchasers:** Should your Airline Micro Earset system ever require servicing, a Return Authorization (RA) number is necessary. Without this number, the unit will not be accepted for return. If your AirLine Micro Earset system was purchased in the United States, please call Samson at 1-800-372-6766 for an RA number prior to shipping your system. If possible, return the unit in its original carton and packing materials. If your AirLine Micro Earset system was purchased outside of the U.S., contact your local distributor for information.

**BATTERY NOTE:** Lithium-ion batteries are low maintenance and provide higher power in a lighter package when compared to NiCad (nickel-cadmium). All Lithium-ion batteries have a finite number of times they can be recharged, called a charge cycle. A charge cycle means using all of the battery's power, but does not necessarily mean a single charge. The battery can be recharged when needed, and does not need to be fully discharged (as compared to NiCad). Repetitive full discharges of the battery should be avoided. Lithium-ion batteries need to be used for maximum life and performance. If you are not using your wireless system often, be sure to complete a full charge cycle at least every three months. If you need to replace your AH2 or AR2 battery please contact Samson or your local distributor.

## System Components

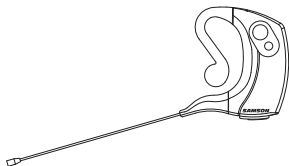

AH2 Transmitter

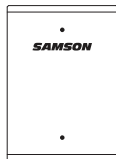

AR2 Receiver

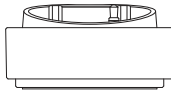

AR2D Dock



Carry Case



Owners Manual

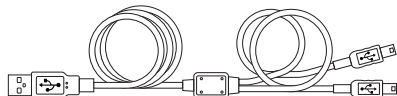

USB Y-Power Cable

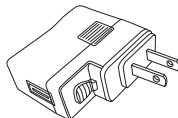

Universal AC Adaptor

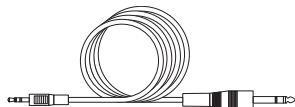

1/8" to 1/4" Audio Cable



3 Windscreens

*Note: Universal AC Adaptor works from 100V - 240V. Plug adaptors snap into place and can be changed by sliding the button below the plug. Each system is shipped with one plug adaptor specific to the country where the system is purchased. Plug adaptors can be ordered through Samson.*

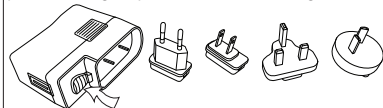

## Quick Start

Please follow these basic procedures for setting up and using your AirLine Micro:

1. For your AirLine Micro system to work correctly, both the receiver and transmitter must be set to the same channel. Remove all packing materials (save them in case your unit needs service in the future) and check to make sure that the supplied receiver and transmitter are set to the same channel.

*Note: The channel number is laser-engraved on the back of the AR2 and AH2 chassis. If these channels do not match, please contact Samson Technical Support at 1-800-372-6766. If your unit was purchased outside of the U.S., please contact your local distributor.*

2. Before using your AirLine Micro system you should fully recharge the transmitter and receiver batteries. Plug the AC adaptor into a power socket. Connect the USB Y-Cable into the USB socket on the AC adaptor. Plug the two mini-USB connectors into the USB ports on the AH2 transmitter and AR2 receiver. When the transmitter and receiver are completely charged, the BLUE LED indicator will turn off.
3. Remove the USB cable and continue with setup.
4. Physically place the receiver where it will be used (if desired, the AR2 receiver model can be used with the included AR2D dock) and fully extend the antennas vertically.
5. Turn your audio system off and connect the receiver's 1/8" unbalanced output jack to the microphone or line level audio input of your amplifier or mixer. Set the AR2 Mic/Line Level switch to match the input.
6. Turn on the receiver using the Power Switch. When on, the Status Indicator will be steady YELLOW.

## Quick Start

7. Turn on your AH2 transmitter by pressing and holding the Multi-Function Switch, until the Status Indicator LED flashes GREEN, then release it. The AH2 Status Indicator will now light steady GREEN. The AR2 receiver Status Indicator will change from YELLOW to GREEN indicating that it is receiving a valid RF signal.
8. Position the AH2 on your head, as illustrated on page 7.
9. Turn on your connected amplifier and/or mixer, but keep its volume all the way down. Make sure the AH2 transmitter is not muted.

*Note: If the AH2 is muted, the AH2 Status Indicator LED will flash GREEN and the AR2 Status Indicator will flash GREEN. To unmute the AH2, press the Multi-Function Switch and the Status Indicator will light steady GREEN.*

10. Speak or sing into the eartset microphone at a normal performance level while slowly raising the audio input control of your amplifier or mixer, until the desired volume is reached.
11. If you hear distortion at the desired volume level, check to see whether the Status Indicator LED on the receiver is lighting RED. If it is not lit, make sure that the gain structure of your audio system is set correctly (consult the owners manual of your mixer and/or amplifier for details). If the Status Indicator is RED, simply move the microphone further from your mouth.

If you hear a weak, noisy signal at the desired volume level, make sure that the gain structure of your audio system and the Audio Output Level switch are correctly set. If the Audio Output Level switch is correctly set and the signal coming from the receiver is still weak and/or noisy, simply position the microphone closer to your mouth.

## Quick Start

If you feel that the level of the microphone needs further adjustment, press and hold the AH2 Multi-Function Switch while the unit is powered on until the Status Indicator turns off, and release the switch. Then press and hold the Multi-Function Switch again for 5 seconds. The AH2 Status Indicator will first flash GREEN then flash YELLOW to show that you are in the Volume Adjustment mode. Press and release the Multi-Function Switch once, and the microphone volume will increase one level. To continue to adjust the microphone volume, press and release the Multi-Function Switch until the maximum level is reached. There are 5 levels. With each increasing level, the Status Indicator will flash faster. After level 5 is reached, the transmitter will cycle back down through the levels each time the Multi-Function Switch is pressed. As the levels decrease, the Status Indicator flashes slower. When the desired level is reached, release the Multi-Function Switch. The AH2 will return to normal operation after 10 seconds, and the Status Indicator will be steady GREEN.

12. Do a walk-around through the intended area of coverage while observing the AR2's Status Indicator; it should stay steadily GREEN, indicating sufficient RF reception in all areas of coverage. If the AR2's Status Indicator lights YELLOW, it designates RF dropout or muted receiver. Reposition the device (or its antennas) as necessary. If extended range coverage is required, another AR2 true diversity receiver (set to the same channel as the transmitter) should be used.
13. If you have followed all the steps above and are experiencing difficulties, please call Samson Technical Support (1-800-372-6766) between 9 AM and 5 PM EST. If you purchased your system outside of the U.S., please contact your local distributor.



## Wearing the AH2 Transmitter

The AH2 can be re-sized to fit comfortably on your ear.

1. Rotate the adjustment band up. (figure 1)
2. Position the AH2 over your left ear so that the body of the transmitter is behind your ear. (figure 2)
3. Push the adjustment band down until it fits comfortably in your ear and is secure against your head. (figure 3)
4. Position the microphone towards the corner of your mouth, approximately 1/2" away from the lips.
5. Position the moisture guard ring as close to the capsule as possible.
6. For outdoor use, and to help reduce p-popping, install one of the included windscreens.

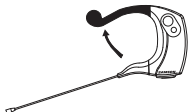

figure 1

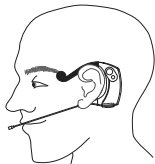

figure 2

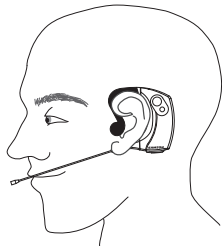
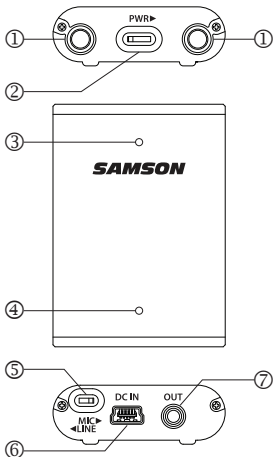
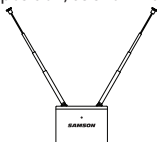

figure 3

## Guided Tour - AR2 Receiver



- 1. Antennas** - The retractable antennas allow full rotation for optimum placement. In normal operation, both antennas should be fully extended and placed in a vertical position, as shown below.



- 2. POWER Switch** - Use this to turn the AR2 power on and off.
- 3. Status Indicator** - This three-color LED acts as a multi-function meter, indicating power, transmitter tone-key status, transmitter mute, and transmitter peak.

YELLOW	AR2 Powered On, No Tone-Key Present
GREEN	AH2 On, Normal Operation
Flashing GREEN	AH2 Audio Muted
RED	Transmitter Input Overloaded

## Guided Tour - AR2 Receiver

- 4. Low Battery Indicator** - This BLUE LED displays the status of the battery. The Low Battery Indicator will flash BLUE when the unit is on, and the battery is low. When recharging the AR2, the LED will be steady BLUE until the battery is fully charged, then the indicator will turn off.
- 5. Audio Output Level Switch** - Sets the audio output level of the unbalanced output to microphone or line level.
- 6. USB DC Power Input** - Connect the supplied universal adaptor to recharge the internal lithium ion rechargeable battery or to power the receiver. The USB DC input will also accept USB bus power from a computer USB port, or any 5-volt DC adaptor that has a USB output (including automotive).  
*NOTE: The USB port is only used for charging purposes and cannot be used for data exchange between a PC and the AR2 receiver.*
- 7. 1/8" Unbalanced Output** - Use this unbalanced (600 Ohm min.) 1/8" (3.5 mm) mini-phone jack when connecting the audio equipment.

## Guided Tour - AH2 Transmitter

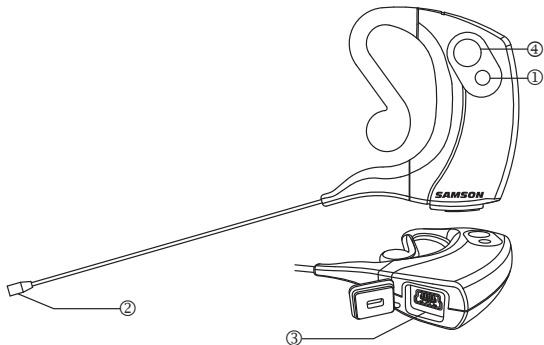

- 1. Status Indicator** - This LED displays the operation mode, low battery and recharge status of the transmitter.

GREEN	Normal Operation
Flashing GREEN	Mute
Flashing YELLOW	Volume Adjustment Mode
Fastest Flashing YELLOW	Maximum Level
Slowest Flashing YELLOW	Minimum Level
Flashing BLUE	Low Battery
BLUE	Recharging - LED will turn off when AH2 is fully charged

- 2. Microphone** - Micro-miniature, 3mm omni-directional microphone capsule.

- 3. USB DC Power Input** - Connect the supplied universal adaptor to recharge the internal Lithium Ion battery. The USB DC input will also accept USB bus power from a computer USB port, or any 5-volt DC adaptor that has a USB output.

*NOTE: The Universal AC Adaptor will charge the AH2 & AR2 faster than a computer USB port.*

*NOTE: The USB port is only used for charging purposes and cannot be used for data exchange between a PC and the AH2 transmitter.*

## Guided Tour - AH2 Transmitter

4. **Multi-Function Switch** - Press and hold to turn the unit on or off. Press and release to mute or unmute the transmitter. To adjust the transmitter volume, while the AH2 is powered on, press and hold until the power turns off, release the switch, then press and hold the switch for 5 seconds and the Status Indicator will first flash GREEN then flashes YELLOW.

Function	Activation	Hold Time	LED Status
Power ON/OFF	Press and Hold	> 1 sec	GREEN
Mute ON/OFF	Press	0.2 - 2 sec	Flashing GREEN
Volume Adjust	Press and Hold	> 5 sec	Flashing YELLOW
Increase Gain	Press (Total 5 steps)	> 0.2 sec	Flashing YELLOW
Decrease Gain	Press (Total 5 steps)	> 0.2 sec	Flashing YELLOW
Set Level	Don't Press	10 sec	GREEN

## AR2 Dock

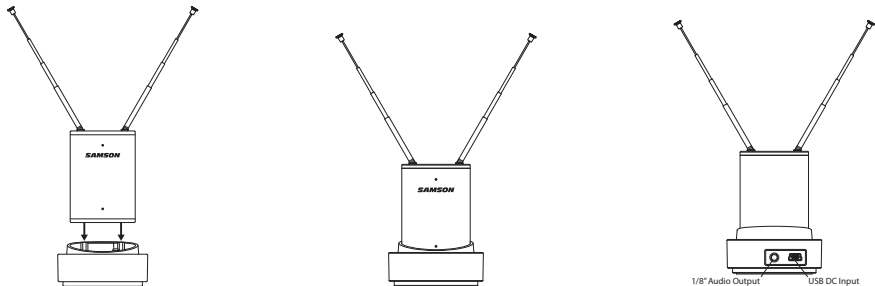

For added convenience and easy setup, we have included the AR2D dock. To use the dock please follow these steps:

1. Slide the AR2 receiver into the AR2D dock. There are two keys on the rear of the AR2 that will match up and align with the AR2D so that the receiver will fit correctly.
2. Attach the included 1/8" to 1/4" audio cable to the audio output on the back panel of the AR2D.
3. To recharge the AR2 receiver, connect the USB Y-cable to the USB DC input on the back panel of the AR2D and connect the cable to the included Universal AC adaptor.

## Specifications

<b>System</b>		Sensitivity	18 dBu (@ THD 2%)
Operating Frequency		Power Requirements	Internal lithium ion rechargeable battery or AC adaptor
N Band	642.375 MHz - 645.750 MHz	Battery Life	~10 hours
E Band	863.125 MHz - 864.875 MHz	Indicators	Power On, Tone Key, Transmitter Mute, Transmitter Peak, Battery Low, Recharging
Number of Channels		Dimensions	43 mm L x 13 mm W x 60 mm H 1.7" L x 0.51" W x 2.4" H
N Band	6	Weight	42g (1.5 oz.)
E Band	4	<b>AH2 Transmitter</b>	
Working Range	100m (300 ft.) line of sight	Audio Input Level	-110 dBv ~ 0 dBv
Audio Frequency Response	100 Hz - 15 kHz	Volume Adjustment Steps	5
T.H.D. (Overall)	< 1% (@AF 1 kHz, RF 46 dBu)	RF Transmitter Output	10 mW ERP
Operating Temperature	-18°C (0°F) to +40°C (+104°F)	Power Requirements	Internal lithium ion rechargeable battery
Storage Temperature	-5°C (23°F) to +35°C (+95°F)	Battery Life	~10 hours
<b>AR2 Receiver</b>		Dimensions	171 mm L x 14 mm W x 58 mm H 6.7" L x 0.6" W x 2.3" H
Audio Output Connector	1/8" Unbalanced	Weight	22 grams (0.8 oz.)
Audio Output Level (Typical)	-30 dBv (Mic), -10 dBv (Line)		
Audio Output Impedance	Unbalanced 600 Ohms		
AF Frequency Response	50 Hz - 15 kHz		
Antennas	Two 1/4 Wavelength Rod		
Selectivity	±150 kHz (AF Out Ratio -60 dB)		
S/N Ratio (Overall)	90 dB (w/IHF-A Filter)		

## AirLine Micro Channel Plan

Channel	Frequencies	Channel	Frequencies
N1	642.375 MHz	E1	863.125 MHz
N2	642.875 MHz	E2	863.625 MHz
N3	644.125 MHz	E3	864.500 MHz
N4	644.750 MHz	E4	864.875 MHz
N5	645.500 MHz		
N6	645.750 MHz		

*Airline Micro N-Channel wireless frequencies are within UHF TV frequency bands. Only certain channels may be available in particular areas. The six N-Channels have been selected for optimum multi-channel compatibility and may be used simultaneously, subject to frequency availability in your geographic area.*

*Airline Micro E-Channel wireless frequencies may not be used in North America.*



CAUTION! Electrical shock can result from removal of the receiver cover. Refer servicing to qualified service personnel.

No user-serviceable parts inside. Do not expose to rain or moisture.

The circuits inside the receiver and transmitter have been precisely adjusted for optimum performance and compliance with federal regulations. Do not attempt to open the receiver or transmitter. To do so will void the warranty, and may cause improper operation.

Power Outlet as a power device should be easy to operate

This device complies with part 15 of the FCC rules. Operation is subject to the condition that this device does not cause harmful interference.

This device complies with RSS-210 of Industry & Science Canada.

Operation is subject to the following two conditions:

(1) this device may not cause harmful interference and

(2) this device must accept any interference received, including interference that may cause undesired operation.

This equipment is intended for use in wireless microphone applications.

Equipment is intended for sale in: AT, BE, CH, CY, CZ\*, DK, EE, FI\*, FR\*, DE\*, GR\*, HU, IE, IS, IT, LV, LT\*, LU, MT\*, NL, NO\*, PL\* PT, RO, SK, SI, ES, SE, UK

\*Subject to license. Please contact your national frequency authority for information on available legal use in your area. Any changes or modifications not expressly approved by Samson Technologies Corp. could void your authority to operate the equipment.

## CE Declaration

CE0197 

We, Samson Technologies Corporation, located at 45 Gilpin Ave, Hauppauge, NY 11788 USA declare under our own responsibility that these devices are in conformity with the essential requirements of R&TTE Directive 1999/5/EC when installed in accordance with the installation instructions contained in the product documentation. To the effect that the standards and/or technical specifications referenced below have been applied as indicated:

EN 62479:20102

EN 60065: 2002+A1+A11+A2+A12

EN 301 489-1 V1.9.2

EN 301 489.9 V1.4.1

EN 300 422-1 V1.4.2

EN 300 422-2 V1.3.1

Year of CE Marking (Low Voltage Directive): 2014

The products shall contain the CE marking and shall be accompanied by the identification number of the Notified Body TÜV Rheinland Product Safety GmbH **0197**. This equipment will also carry the Class 2 equipment identifier.

Signed on behalf of the manufacturer:



Douglas Bryant

Vice President Engineering

03/03/2014

### **FCC Consumer Alert for Wireless Microphones**

Most users do not need a license to operate this wireless microphone system. Nevertheless, operating this microphone system without a license is subject to certain restrictions: the system may not cause harmful interference; it must operate at a low power level (not in excess of 50 milliwatts); and it has no protection from interference received from any other device. Purchasers should also be aware that the FCC is currently evaluating use of wireless microphone systems, and these rules are subject to change. For more information, call the FCC at 1-888-CALL-FCC (TTY: 1-888-TELL-FCC) or visit the FCC's wireless microphone website at [www.fcc.gov/cgb/wirelessmicrophones](http://www.fcc.gov/cgb/wirelessmicrophones).



If you want to dispose this product, do not mix it with general household waste. There is a separate collection system for used electronic products in accordance with legislation that requires proper treatment, recovery and recycling.

Private household in the 28 member states of the EU, in Switzerland and Norway may return their used electronic products free of charge to designated collection facilities or to a retailer (if you purchase a similar new one).

For Countries not mentioned above, please contact your local authorities for a correct method of disposal.

By doing so you will ensure that your disposed product undergoes the necessary treatment, recovery and recycling and thus prevent potential negative effects on the environment and human health.

## AirLine Micro Function & Indicator Guide

---

### AH2 Earset Transmitter

#### Status

#### Earset Status Indicator Light

Powering On

Steady **GREEN**.

Mute

Intermittent **GREEN** flashes.

Volume Adjust

Intermittent **YELLOW** flashes. The indicator flashes faster as the volume is increased. The indicator flashes slower as the volume is decreased.

Battery Low

The indicator flashes **BLUE**.

Charging Battery

Steady **BLUE**. Indicator turns off when the battery is fully charged.

---

### AR2 Receiver

#### Status

#### Receiver Indicator Lights

Powering On

Status Indicator: Steady **YELLOW**.

(AR2: ON, AH2: OFF)

Powering On

Status Indicator: Steady **GREEN**.

(AR2: ON, AH2: ON)

AH2 Mute

Status Indicator: Intermittent **GREEN** flashes.

Peak

Status Indicator: Flashes **RED**.

Battery Low

Low Battery Indicator: Intermittent **BLUE** flashes.

Charging Battery

Low Battery Indicator: Steady **BLUE**. Indicator turns off when the battery is fully charged.

---