

iKlip Grip Pro



Made in Italy

For the complete user manual, visit:

Pour le manuel d'utilisation complet, visitez:

Para consultar el manual de usuario completo, vaya a:

Para consultar o manual de usuário completo, visite:

Per consultare il manuale utente completo, visitare:

Ein vollständiges Benutzerhandbuch finden Sie auf:

詳しいマニュアルは、下記にて:

查看完整的用户手册，请访问:

查看完整的用戶手冊，請訪問:

설명서 전부를 보시려면 다음 웹사이트를 방문하십시오 :

Для получения полного руководства пользователя посетите:



ikmanual.com/iklipgrip

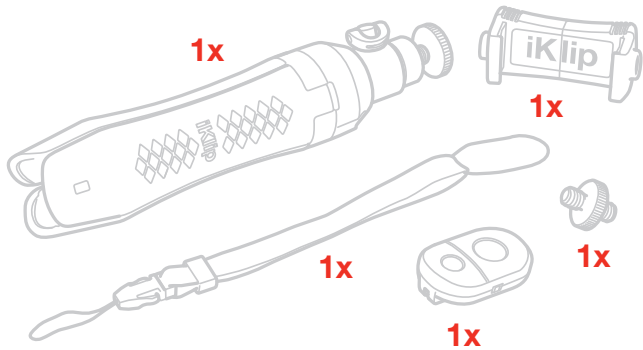

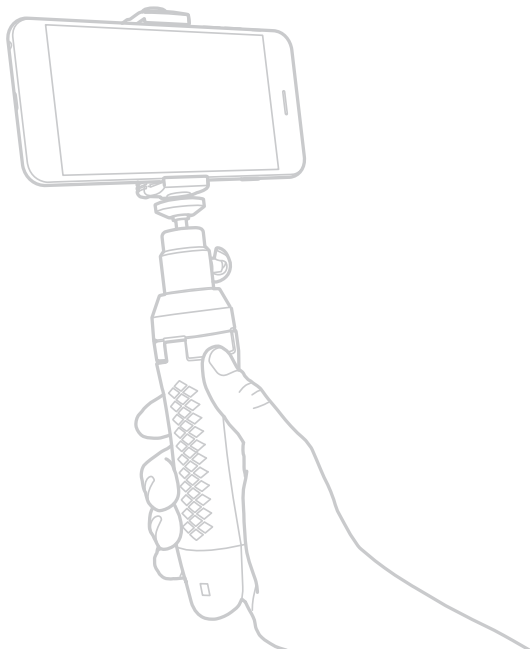

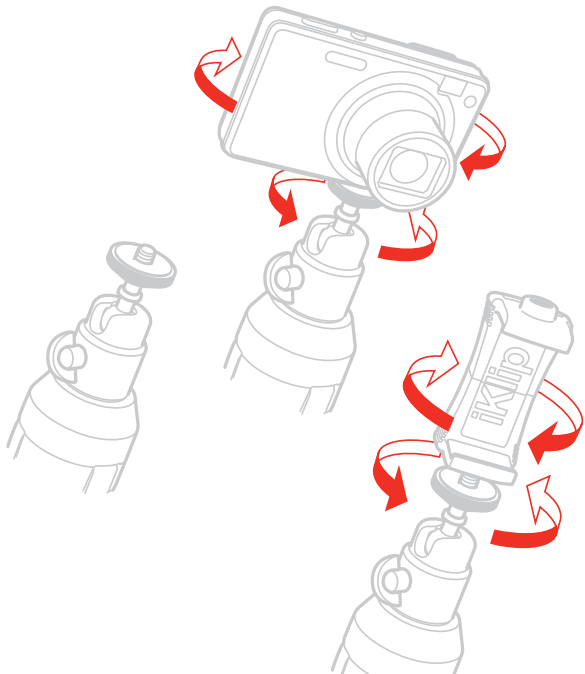

up to
3.58"/
91mm

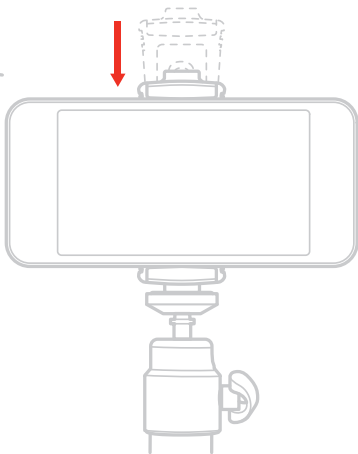
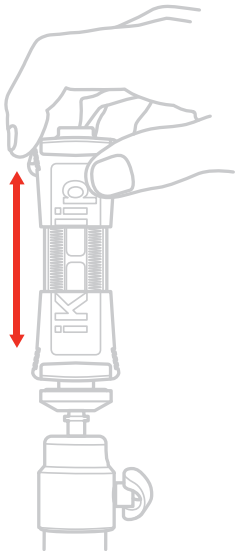

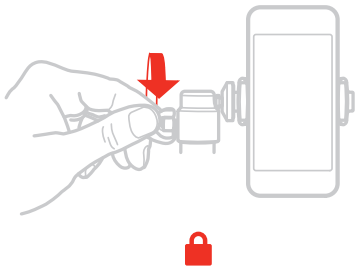
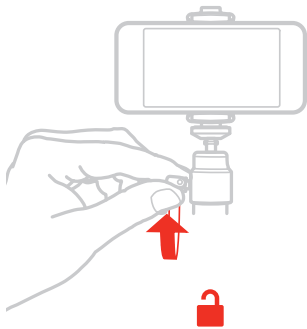
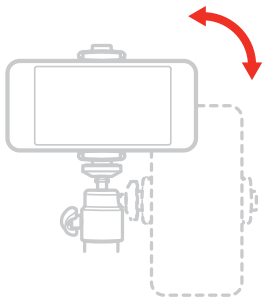

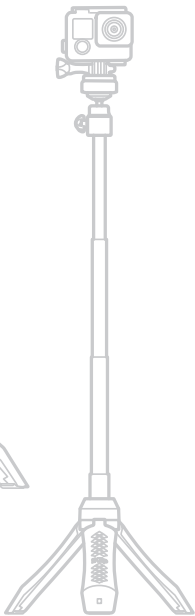
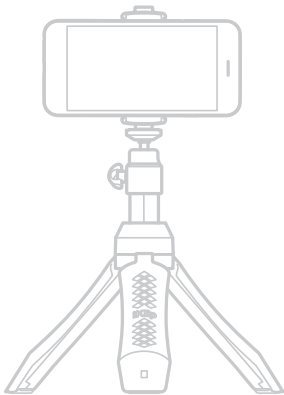
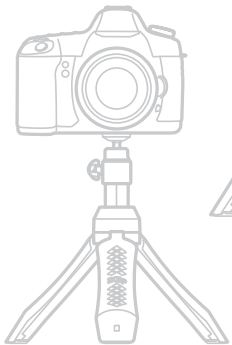

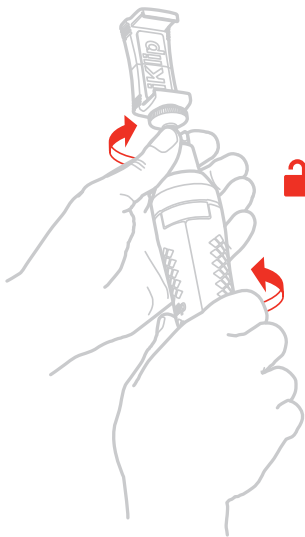
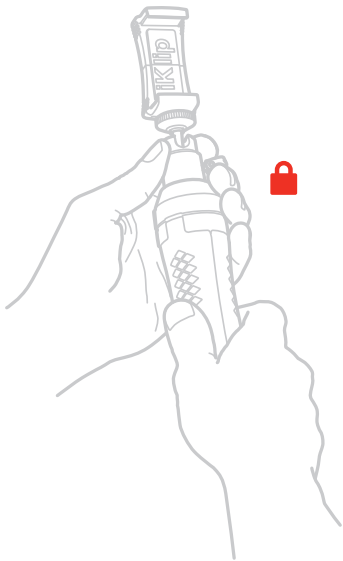

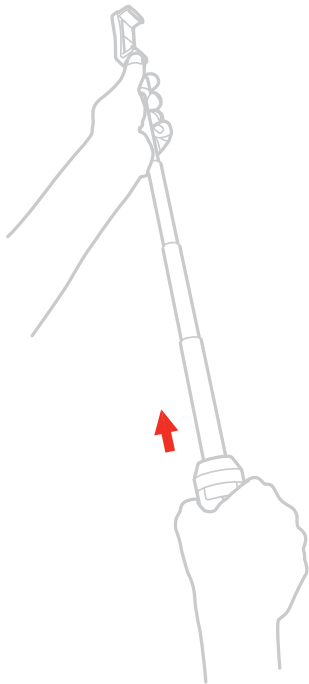

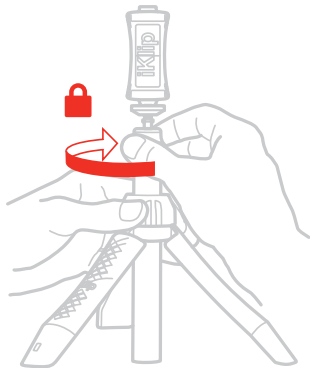
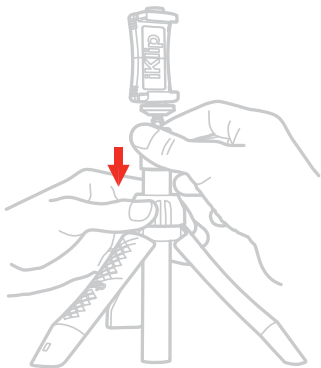

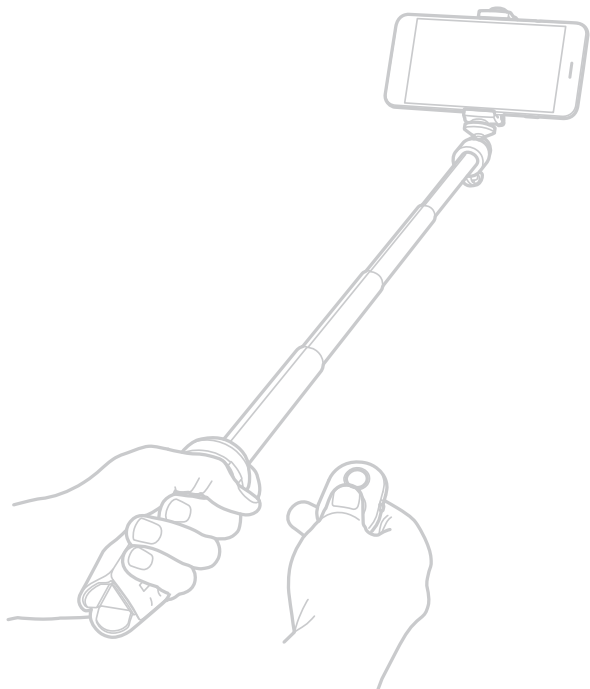

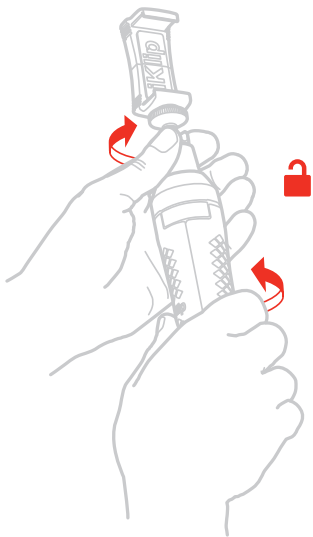
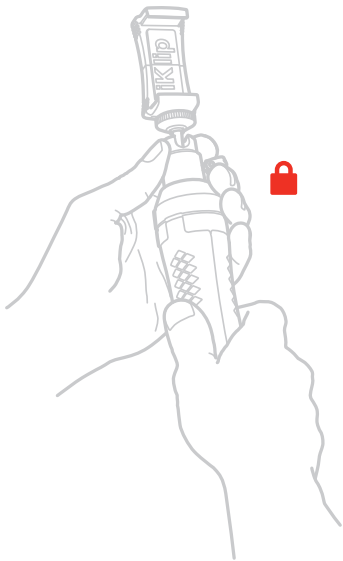

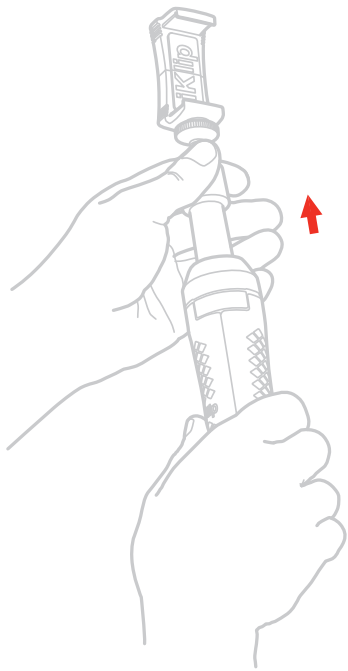

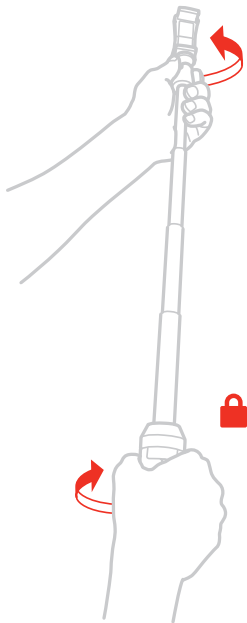
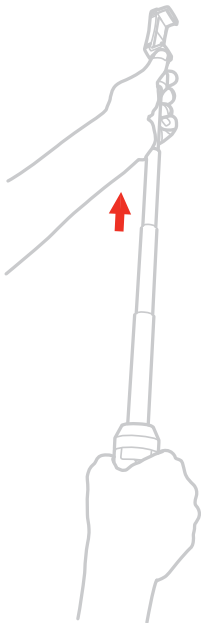

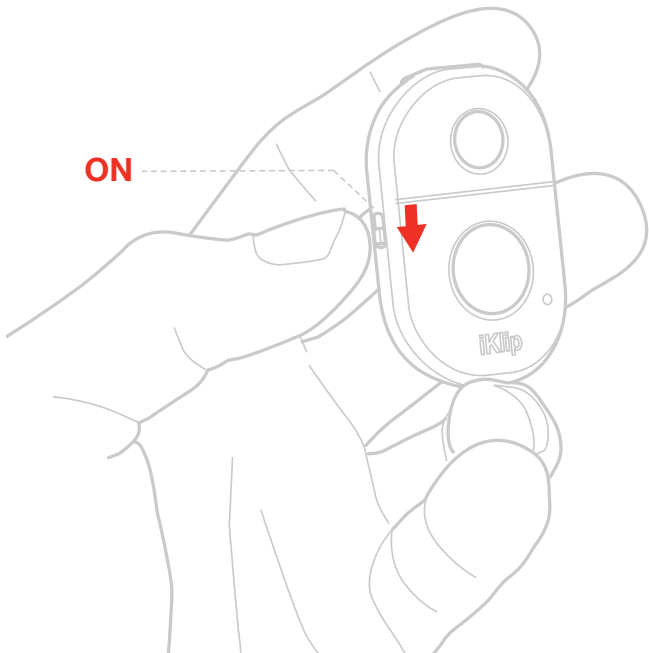

ON



iKlip

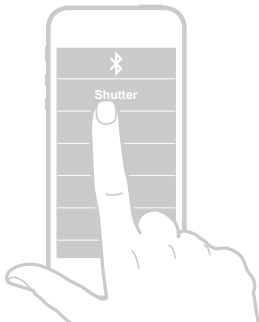



Android

iPhone,
iPod touch,
iPad

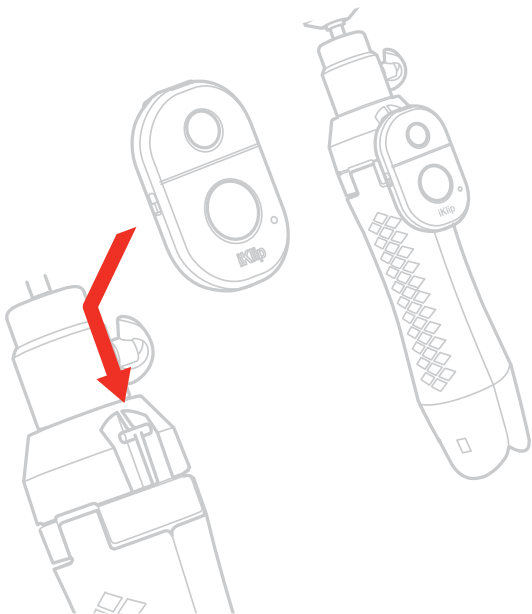

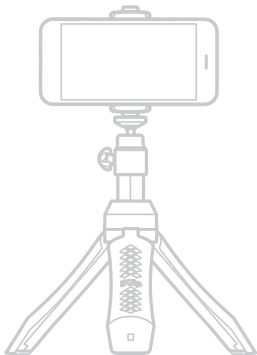
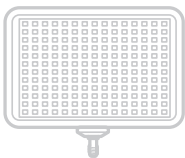
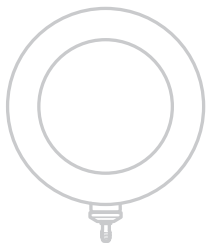

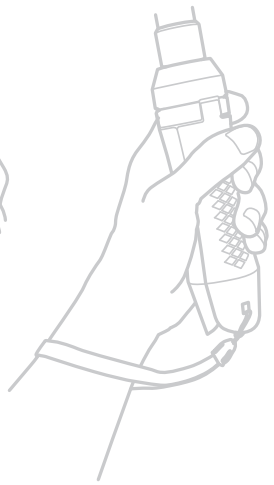
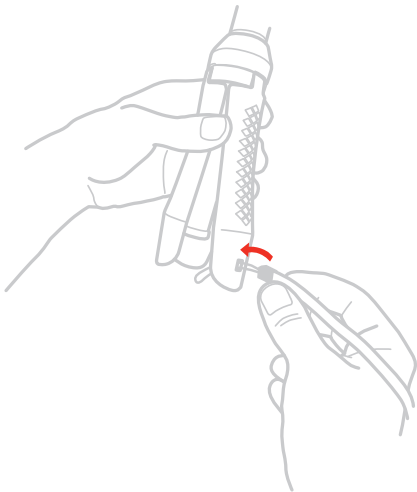

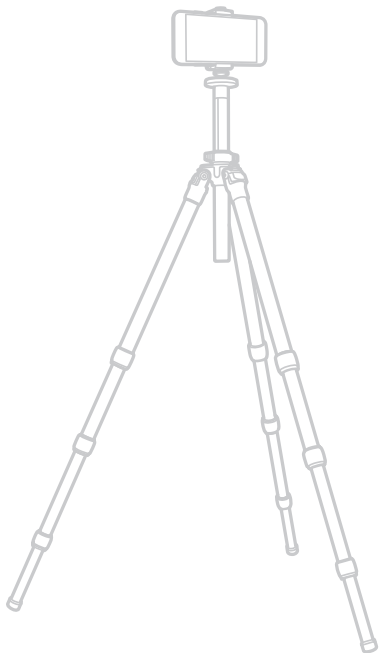
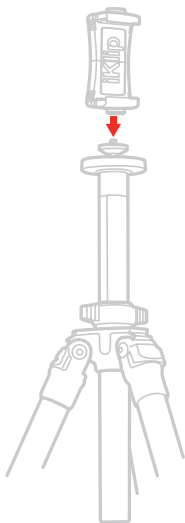

Regulatory

Model: iKlip Grip Pro

Model Number: IK000084

Bluetooth Shutter Model Number: 084-104-1-01 (Contains part SFR1002)

U.S.A.

Contains Bluetooth shutter with FCC ID : 2ADMCSF2001



FCC statement

This device complies with Part 15 of the FCC Rules. Operation is subject to the following two conditions:

1. This device may not cause harmful interference.
2. This device must accept any interference received, including interference that may cause undesired operation.

Changes or modifications not expressly approved by the party responsible for compliance could void the user's authority to operate the equipment.

NOTE: This equipment has been tested and found to comply with the limits for a Class B digital device, pursuant to Part 15 of the FCC Rules. These limits are designed to provide reasonable protection against harmful interference in a residential installation.

This equipment generates, uses, and can radiate radio frequency energy and, if not installed and used in accordance with the instructions, may cause harmful interference to radio communications. However, there is no guarantee that interference will not occur in a particular installation. If this equipment does cause harmful interference to radio or television reception, which can be determined by turning the equipment off and on, the user is encouraged to try to correct the interference by one or more of the following measures:

1. Reorient or relocate the receiving antenna.
2. Increase the separation between the equipment and receiver.
3. Connect the equipment into an outlet on a circuit different from that to which the receiver is connected.
4. Consult the dealer or an experienced radio/TV technician for help.

FCC radiation exposure statement

This equipment complies with FCC radiation exposure limits set forth for an uncontrolled environment. This equipment should be installed and operated with minimum distance 20cm between the radiator & your body. End users must follow the specific operating instructions for satisfying RF exposure compliance. This transmitter must not be co-located or operating in conjunction with any other antenna or transmitter.

CANADA

Contains/Contient Bluetooth shutter with IC ID: 20638-SFR1002

IC statement/warning

This device complies with Industry Canada licence-exempt RSS standard(s). Operation is subject to the following two conditions:

1. This device may not cause interference, and
2. This device must accept any interference, including interference that may cause undesired operation of the device.

To comply with Industry Canada RF radiation exposure limits for general population, the antenna(s) used for this transmitter must be installed such that a minimum separation distance of 20cm is maintained between the radiator (antenna) and all persons at all times and must not be co-located or operating in conjunction with any other antenna or transmitter

Changes or modifications not expressly approved by the party responsible for compliance could void the user's authority to operate the equipment.

Avertissement IC

Le présent appareil est conforme aux CNR d'Industrie Canada applicables aux appareils radio exempts de licence. L'exploitation est autorisée aux deux conditions suivantes:

1. l'appareil ne doit pas produire de brouillage, et
2. l'utilisateur de l'appareil doit accepter tout brouillage radioélectrique subi, même si le brouillage est susceptible d'en compromettre le fonctionnement.

Pour satisfaire les limites d'exposition aux radiations RF de l'Industry Canada, les antennes utilisées pour cet émetteur doivent être installées de façon telle qu'au moins 20cm séparent l'émetteur (antenne) de toute personne, et ne doivent être ni situées ni utilisées en conjonction avec n'importe quelle autre antenne ou émetteur.

EUROPE



AUSTRALIA/NEW ZEALAND



BRAZIL

Modelo: Remote Shutter



04464-15-05139

Technical Specifications / Especificações técnicas:

Operation Frequency / Frequência de operação: 2402-2480 MHz

Bluetooth Version / Versão do Bluetooth: V3.0

Modulation / Modulação: GFSK

Este equipamento opera em caráter secundário, isto é, não tem direito a proteção contra interferência prejudicial, mesmo de estações do mesmo tipo, e não pode causar interferência a sistemas operando em caráter primário.

UNITED ARAB EMIRATES

TRA

REGISTERED N°: ER48399/16

DEALER N°: DA45962/15

SINGAPORE

Complies with
IDA Standards
DA00006A

JAPAN



204-520308

CHINA

CMIIT ID: 2015DP5291

KOREA

	상호 또는 성명	Shenzhen Kinlan Technology Limited
	기자재의 명칭	특정소출력 무선기기(무선데이터통신시스템용무선기기)
	모델명	SFR1002
	인증번호	MSIP-CRM-KIN-SFR1002
	제조연월	2015.10
	제조사/제조국가	Shenzhen Kinlan Technology Limited / 중국
해당 무선설비는 운용 중 전파(천파)혼신 가능성이 있음 *		

For warranty information, please visit:

Pour plus d'informations sur la garantie, veuillez visiter:

Para información sobre la garantía, por favor visite:

Para obter informações de garantia, por favor visite:

Per informazioni sulla garanzia, visitare:

Für Garantieinformationen, besuchen Sie bitte:

製品保証については、下記をご覧ください:

查看产品保修信息，请访问:

查看產品保修信息，請訪問:

보증 관련 사항은 다음 웹사이트를 방문하십시오:

Для получения информации о гарантийном, пожалуйста, посетите:



ikmultimedia.com/warranty



ikmultimedia.com/support

IK Multimedia. Musicians First.