



# SX215 TOURMAX

**QUICKSTART GUIDE**  
ENGLISH

**GUÍA DE INICIO RÁPIDO**  
ESPAÑOL

**GUIDE D'UTILISATION RAPIDE**  
FRANÇAIS

**GUIDA RAPIDA**  
ITALIANO

**SCHNELLSTART-ANLEITUNG**  
DEUTSCH

**SNELSTARTGIDS**  
NEDERLANDS

## BOX CONTENTS

- TOURMAX speaker
- Quickstart Guide
- Safety Instructions & Warranty Information Booklet

## CONNECTION DIAGRAM

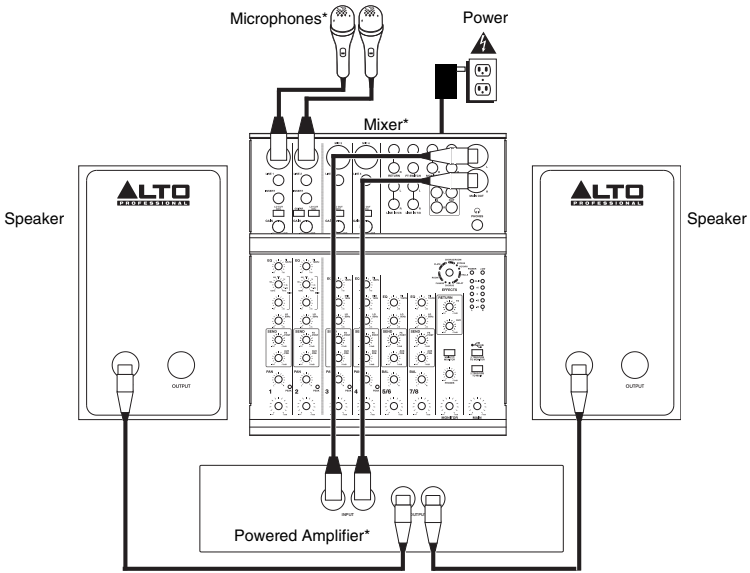

*\*Note: Microphones, mixer, amp, and cables are not included.*

## INSTALLATION

This speaker should be installed securely on a stand on the floor, according to its maximum weight, or suspended from its suspension points (M10 x 1.5PH, 30mm length) (see image for an example). We do NOT recommend suspending multiple speakers in a vertical array.

Example:

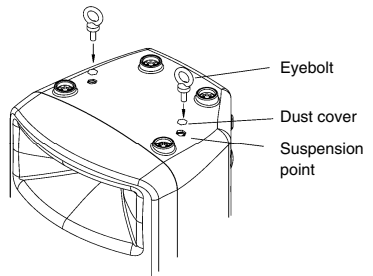

## REAR PANEL OVERVIEW

1. **INPUT** – Use a standard Speakon\* cable (not included) to connect your powered amplifier to this input.
2. **OUTPUT** – Use a standard Speakon cable (not included) to connect this jack to the input of another speaker (i.e., another TOURMAX speaker).

1

INPUT

2

OUTPUT

\* Speakon is a trademark of Neutrik® AG, registered in the U.S. and other countries.

## CONTENIDO DE LA CAJA

- Altavoz TOURMAX
- Guía de inicio rápido
- Folleto de instrucciones de seguridad e información sobre la garantía

## DIAGRAMA DE CONEXIÓN

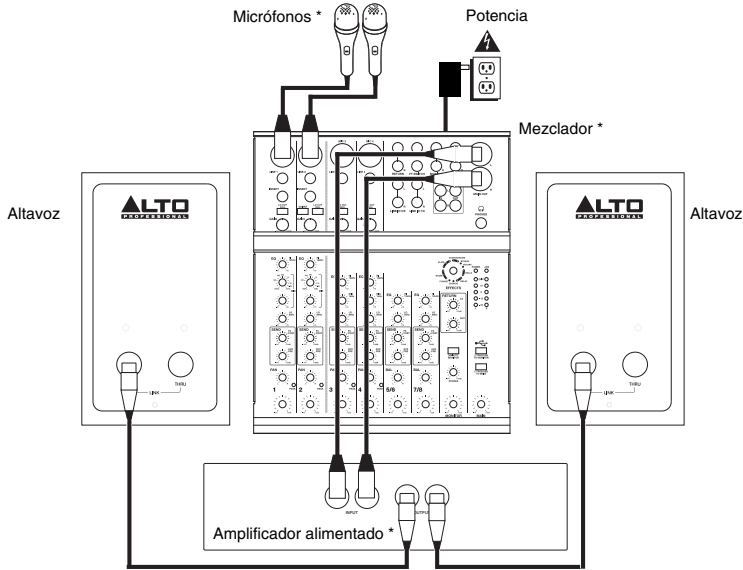

*\*Nota: No se incluyen micrófonos, mezclador, amplificador y cables.*

## INSTALACIÓN

Este altavoz debe instalarse sobre un soporte colocado en el suelo, de acuerdo a su peso máximo, o suspendido de sus puntos de suspensión (M10 x 1.5PH, 30 mm de longitud) (vea la imagen de ejemplo). NO recomendamos suspender varios altavoces en un arreglo vertical.

Ejemplo:

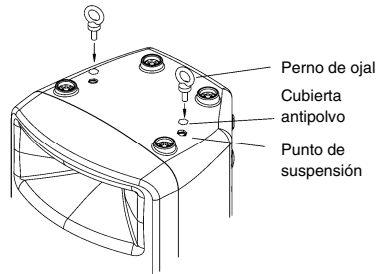

## VISTA DEL PANEL TRASERO

1. **ENTRADA** – Use un cable Speakon\* estándar (no incluido) para conectar su amplificador alimentado a esta entrada.
2. **CONEXIÓN PASANTE** – Use un cable Speakon estándar (no incluido) para conectar este conector a la entrada de otro altavoz (por ej. otro altavoz TOURMAX).

\* Speakon es una marca comercial de Neutrik® AG., registrada en EE.UU. y otros países.

1

INPUT

2

OUTPUT

## CONTENU DE LA BOÎTE

- Haut-parleur TOURMAX
- Guide d'utilisation simplifié
- Consignes de sécurité et informations concernant la garantie

## SCHÉMA DE CONNEXION

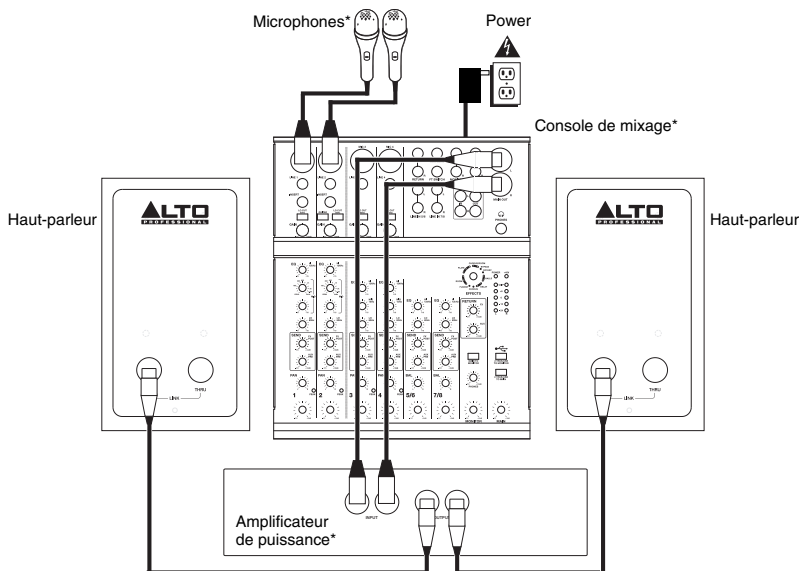

\*Remarque : Microphones, câbles, console de mixage et amplificateur non inclus.

## INSTALLATION

Ce haut-parleur doit être installé sur un pied sur le plancher, en fonction de son poids maximum, ou suspendu par ses points d'ancrage (M10 x 1,5 PH, 30 mm de longueur) (Consultez l'image). Nous NE RECOMMANDONS PAS de suspendre plusieurs haut-parleurs ensemble.

Exemple :

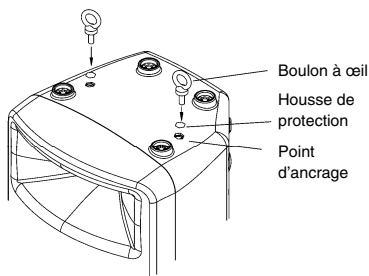

## CARACTÉRISTIQUES DU PANNEAU ARRIÈRE

1. **ENTRÉE** – Utilisez un câble Speakon\* standard (non inclus) pour brancher l'amplificateur de puissance à cette entrée.
2. **SORTIE RELAIS** – Utilisez un câble Speakon standard (non inclus) pour brancher cette sortie à l'entrée d'un autre haut-parleur, tel qu'un autre haut-parleur TOURMAX.

\* Speakon est une marque de commerce déposée de Neutrik® AG, enregistrée aux États-Unis et dans d'autres pays.

1

INPUT

2

OUTPUT

## CONTENUTI DELLA CONFEZIONE

- Altoparlante TOURMAX
- Guida rapida
- Istruzioni di sicurezza e garanzia

## SCHEMA DEI COLLEGAMENTI

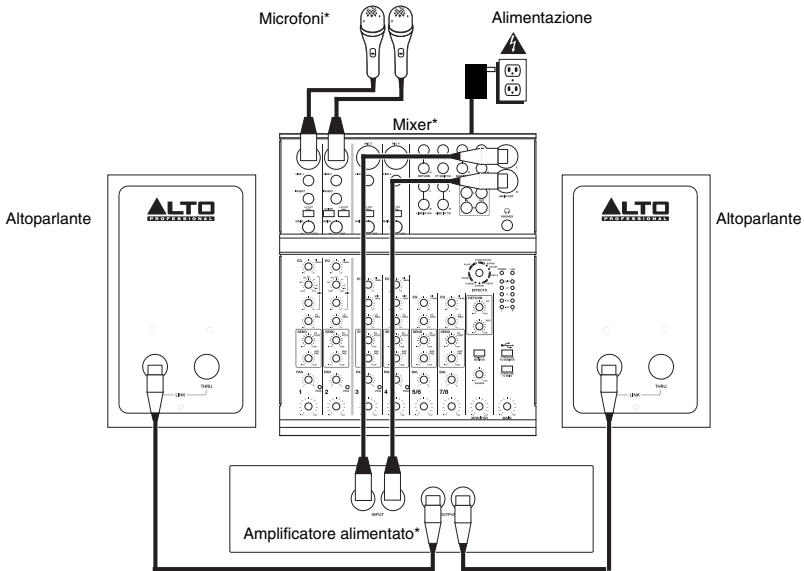

\*Nota bene: microfoni, mixer, monitor, amplificatore e cavi non in dotazione.

## INSTALLAZIONE

Questo altoparlante deve essere installato su un supporto da pavimento, in base al suo peso massimo, oppure appeso servendosi degli appositi punti di sospensione (M10 x 1,5PH, 30 mm di lunghezza) (si veda l'immagine di esempio). NON si consiglia di sospendere più altoparlanti in verticale.

Esempio:

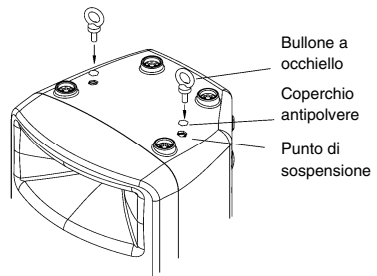

## PANORAMICA PANNELLO POSTERIORE

1. **INGRESSO** – Servirsi di un cavo standard Speakon\* (non in dotazione) per collegare un amplificatore alimentato a questo ingresso.
2. **THRU** – Servirsi di un cavo standard Speakon (non in dotazione) per collegare questo jack all'ingresso di un altro altoparlante (ad es. un altro altoparlante TOURMAX).

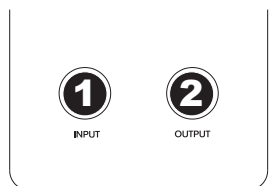

\* Speakon è un marchio di fabbrica di Neutrik® AG, registrato negli Stati Uniti e in altri Paesi.

## LIEFERUMFANG

- TOURMAX Lautsprecher
- Schnellstart-Anleitung
- Sicherheitshinweise und Garantieinformationen

## ANSCHLUSSÜBERSICHT

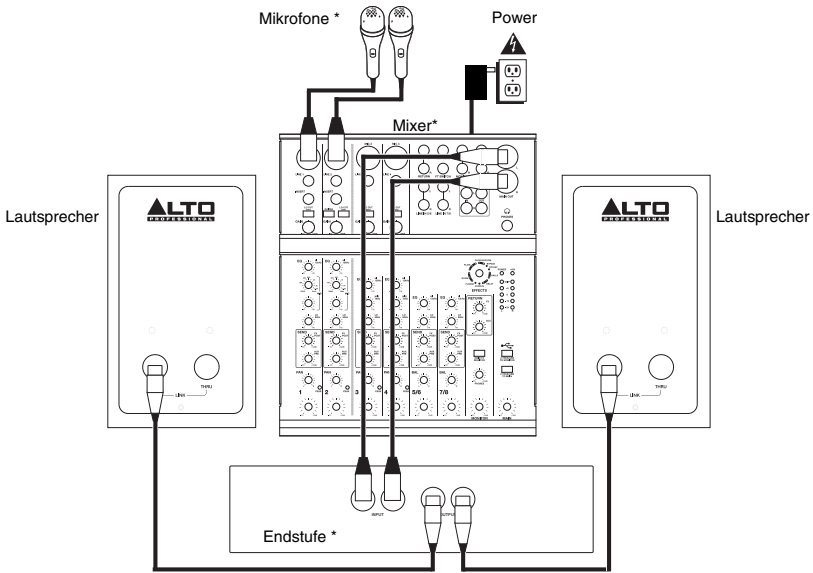

*\*Hinweis: Mikrofone, Mixer, Monitore, Verstärker und Kabel sind nicht im Lieferumfang enthalten.*

## MONTAGE

Dieser Lautsprecher sollte seinem Maximalgewicht entsprechend auf einem Bodenstativ montiert oder an den Aufhängepunkten aufgehängt werden (M10 x 1.5PH, 30mm Länge) (siehe Beispielbild). Mehrere Lautsprecher vertikal aufzuhängen ist NICHT empfehlenswert.

Beispiel:

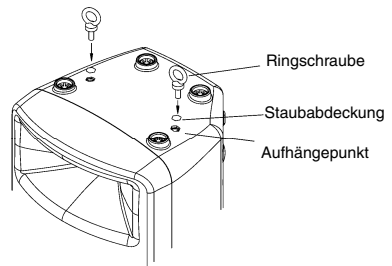

## ÜBERSICHT RÜCKSEITE

1. **EINGANG** – Verwenden Sie ein handelsübliches Speakon\*-Kabel (nicht im Lieferumfang enthalten), um Ihre Endstufe an diesen Eingang anzuschließen.
2. **THRU** – Verwenden Sie ein handelsübliches Speakon-Kabel (nicht im Lieferumfang enthalten), um diese Buchse mit dem Eingang eines anderen Lautsprechers (d.h. eines weiteren TOURMAX Lautsprechers) zu verbinden.

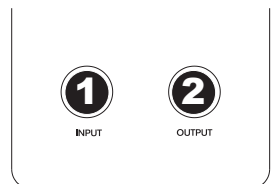

*\* Speakon ist ein Warenzeichen der Neutrik® AG und ist in den USA und anderen Ländern eingetragen.*

## INHOUD VAN DE DOOS

- TOURMAX luidspreker
- Snelstartgids
- Veiligheidsvoorschriften & boekje met informatie over de garantie

## VERBINDINGSDIAGRAM

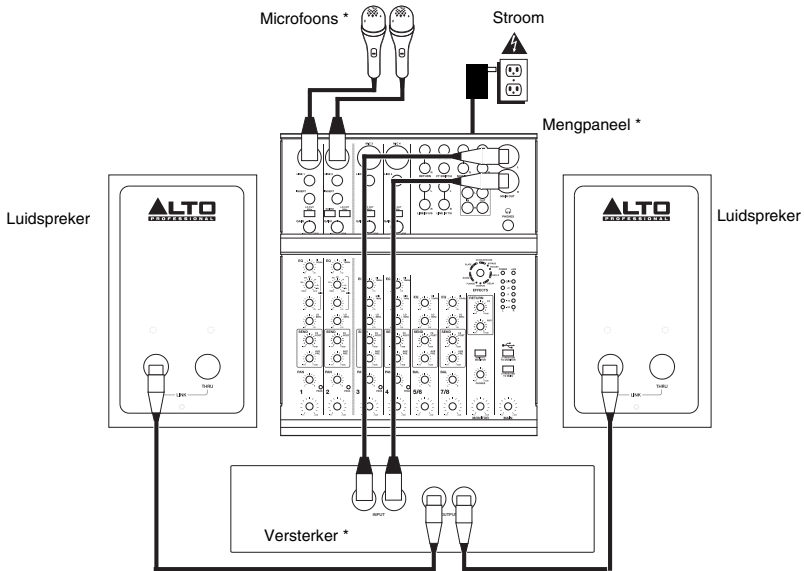

\* **Opmerking:** Microfoons, mengpaneel, versterker en kabels zijn niet inbegrepen.

## INSTALLATIE

Deze luidspreker dient te worden geplaatst op een vloerstatief aangepast aan het maximumgewicht, of opgehangen aan zijn ophangpunten (M10 x 1.5PH, 30 mm lengte) (zie afbeelding als voorbeeld). Wij raden u NIET aan meerdere luidsprekers in een verticale opstelling op te hangen.

Voorbeeld:

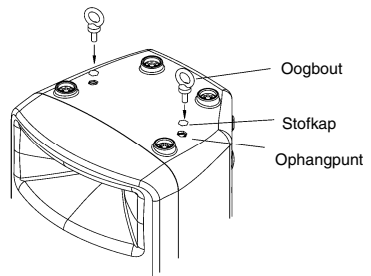

## OVERZICHT ACHTERPANEEL

1. **INPUT** – Gebruik een standaard Speakon-kabel\* (niet meegeleverd) om uw versterker met deze ingang te verbinden.
2. **THRU** – Gebruik een standaard Speakon-kabel (niet meegeleverd) om deze aansluiting te verbinden met de ingang van een andere luidspreker (bijv. een andere TOURMAX-luidspreker).

\* Speakon is een handelsmerk van Neutrik® AG, geregistreerd in de VS en andere landen.

1  
INPUT

2  
OUTPUT

**SPECIFICATIONS**

<b>Output power:</b>	500 W Continuous RMS, 1000 W Program, 2000 W peak
<b>Crossover:</b>	250 Hz ~ 2 kHz (@ 12 dB/Oct)
<b>Max SPL @ 1m:</b>	127 dB Program, 130 dB Peak
<b>Frequency Response:</b>	55 Hz – 20 kHz (@ -10 dB)
<b>Nominal Impedance:</b>	4Ω
<b>Low Frequency:</b>	2 x 15" (381 mm) woofer, 2.5" (64mm) voice coil
<b>High Frequency:</b>	1" (25 mm) driver, 1.35" (34 mm) voice coil
<b>Connectors:</b>	Input: Speakon* Link: Speakon
<b>Cabinet:</b>	Trapezoidal, multi-layer plywood, black paint finish
<b>Coverage:</b>	90° H x 60° V Elliptical wave guide
<b>Dimensions (H x W x D):</b>	43.3" x 17.7" x 17.4" (1100 mm x 450 mm x 443 mm)
<b>Weight (speaker only):</b>	78.7 lbs (35.7 kg)

\* Speakon is a trademark of Neutrik® AG, registered in the U.S. and other countries.



THIS DEVICE COMPLIES WITH PART 15 OF THE FCC RULES. OPERATION IS SUBJECT TO THE FOLLOWING TWO CONDITIONS: (1) THIS DEVICE MAY NOT CAUSE HARMFUL INTERFERENCE, AND (2) THIS DEVICE MUST ACCEPT ANY INTERFERENCE RECEIVED, INCLUDING INTERFERENCE THAT MAY CAUSE UNDESIRED OPERATION.

**[www.altoprofessional.com](http://www.altoprofessional.com)**